

# AUTOMOTIVE LED LIGHT LEADER



**VEDERCI MEGLIO ALLA GUIDA  
VIAGGIANDO IN SICUREZZA**

*UPGRADING 21.3*



HAPPY SOUND GROUP è un'azienda Sammarinese che opera nel settore della tecnologia dei veicoli da oltre 25 anni.

Oggi HAPPY SOUND GROUP è leader nella tecnologia a led per veicoli.

Ci rechiamo personalmente presso i nostri fornitori nel mondo per verificare che rispettino la qualità costruttiva da noi richiesta e progettata. Infatti i nostri fornitori costruiscono molti prodotti su nostro progetto esclusivo, questo ci permette di commercializzare articoli unici nel settore.

La qualità, l'innovazione, sono il nostro motto.

Commercializziamo prodotti con il nostro packaging brand "HS GROUP" tramite la nostra rete vendita. Da tempo siamo fornitori di grandi aziende italiane e consorzi di ricambisti.

Il nostro staff è composto da personale tecnico e commerciale con elevata esperienza, che mettiamo al Vostro servizio.

Tutti i nostri articoli sono omologati e sono da noi garantiti a termini di legge.



**HS GROUP SEMPRE ALL'AVANGUARDIA AL VOSTRO FIANCO**

**COMMERCIAL & MARKETING DIRECTOR - Fabio Gentile**  
[fabiogentile@happysoundgroup.com](mailto:fabiogentile@happysoundgroup.com) - +39 345 3222107

**IMPORT/EXPORT DIRECTOR - Fabio Gentile**  
[fabiogentile@happysoundgroup.com](mailto:fabiogentile@happysoundgroup.com) - +39 345 3222107

**DIRETTORE AMMINISTRATIVO - Giovanni Terenzi - info@happysound.it**

**DIRETTORE TECNICO - Giovanni Terenzi - info@happysound.it**

**TRASMISSIONE ORDINI - ordini.hsgroup@gmail.com**

**SEGRETERIA - Francesca Maria Ivagnes - happysoundsanmarino@gmail.com**

**ASSISTENZA TECNICA - service.hsgroup@gmail.com**

**VUOI RICEVERE ASSISTENZA TECNICA?**

**SCRIVI AL NUMERO +39 345 3222107**

**OPPURE AL NUMERO +39 331 9980383**

**PER ESSERE INSERITO NEL NOSTRO**

**GRUPPO DI WHATSAPP NAZIONALE,**

**DEDICATO ESCLUSIVAMENTE**

**ALL'ASSISTENZA TECNICA SUL LED AUTOMOTIVE**



[www.happysoundgroup.com](http://www.happysoundgroup.com)

**HAPPY SOUND GROUP ( H S GROUP)**

**hs\_group\_official**





# CUSTOM LINE. PLUG AND PLAY.

I KIT A LED CUSTOM LINE PERMETTONO DI SOSTITUIRE LE LAMPADE ORIGINALI XENON IN LAMPADE LED SENZA ALCUNA MODIFICA, UTILIZZANDO I CONNETTORI ORIGINALI. NESSUNA SEGNALAZIONE DI ERRORE.

**AUMENTO LUMINOSITÀ:  
+150%**

**DA XENON ORIGINALE A LED 6000 LM**

ART. 40617 CUSTOM LED HEADLIGHTS SET (2 PCS.)



**PLUG AND PLAY**  
(CONNETTORE ORIGINALE,  
SENZA MODIFICARE IMPIANTO)

**ALTA LUMINOSITÀ  
6000 LUMEN**

**WHITE 6000K**

**ALUMINUM  
LIGHT BODY**

**55W**

### TABELLA DI COMPATIBILITÀ

QUESTO PRODOTTO PUÒ ESSERE INSTALLATO SUI SEGUENTI VEICOLI

MARCA	MODELLO	ANNO
VOLKSWAGEN	ALLTRACK	2017
VOLKSWAGEN	E-GOLF	2015-2017
VOLKSWAGEN	E05	2012-2016
VOLKSWAGEN	GOLF	2010-2017
VOLKSWAGEN	GOLF R	2012-2013, 2015-2017
VOLKSWAGEN	GTI	2010-2017
VOLKSWAGEN	SPORTWAGEN	2010-2014
VOLKSWAGEN	TIGUAN	2012-2017
MERCEDES-BENZ	VITO	2010-2012



ART. 40930

**D1S  
D1R**

**PLUG AND PLAY**  
(CONNETTORE ORIGINALE,  
SENZA MODIFICARE IMPIANTO)

### CUSTOM LED HEADLIGHTS SET (2 PCS.)

- PLUG AND PLAY (CONNETTORE ORIGINALE, SENZA MODIFICARE IMPIANTO)
- COLOR: 6000K
- CONTINUOUS POWER: 35W
- MAX OPERATING TEMPERATURE: 90°
- MINIMUM OPERATING TEMPERATURE: -50°
- LUMEN: 6000LM
- HEAT DISSIPATION SYSTEM: TURBINE FUN
- HEAT DISSIPATION MATERIAL: ALUMINIUM
- DIMENSIONS: COME ORIGINALE

ART. 40932

**D3S  
D3R**

**PLUG AND PLAY**  
(CONNETTORE ORIGINALE,  
SENZA MODIFICARE IMPIANTO)

**PARABOLA &  
LENTICOLARE**



### CUSTOM LED HEADLIGHTS SET (2 PCS.)

- PLUG AND PLAY (CONNETTORE ORIGINALE, SENZA MODIFICARE IMPIANTO)
- COLOR: 6000K
- CONTINUOUS POWER: 35W
- MAX OPERATING TEMPERATURE: 90°
- MINIMUM OPERATING TEMPERATURE: -50°
- LUMEN: 6000LM
- HEAT DISSIPATION SYSTEM: TURBINE FUN
- HEAT DISSIPATION MATERIAL: ALUMINIUM
- DIMENSIONS: COME ORIGINALE

ART. 40931

**D2S  
D2R**

**PLUG AND PLAY**  
(CONNETTORE ORIGINALE,  
SENZA MODIFICARE IMPIANTO)

**PARABOLA &  
LENTICOLARE**



### CUSTOM LED HEADLIGHTS SET (2 PCS.)

- PLUG AND PLAY (CONNETTORE ORIGINALE, SENZA MODIFICARE IMPIANTO)
- COLOR: 6000K
- CONTINUOUS POWER: 35W
- MAX OPERATING TEMPERATURE: 90°
- MINIMUM OPERATING TEMPERATURE: -50°
- LUMEN: 6000LM
- HEAT DISSIPATION SYSTEM: TURBINE FUN
- HEAT DISSIPATION MATERIAL: ALUMINIUM
- DIMENSIONS: COME ORIGINALE

ART. 40933

**D4S  
D4R**

**PLUG AND PLAY**  
(CONNETTORE ORIGINALE,  
SENZA MODIFICARE IMPIANTO)

**PARABOLA &  
LENTICOLARE**



### CUSTOM LED HEADLIGHTS SET (2 PCS.)

- PLUG AND PLAY (CONNETTORE ORIGINALE, SENZA MODIFICARE IMPIANTO)
- COLOR: 6000K
- CONTINUOUS POWER: 35W
- MAX OPERATING TEMPERATURE: 90°
- MINIMUM OPERATING TEMPERATURE: -50°
- LUMEN: 6000LM
- HEAT DISSIPATION SYSTEM: TURBINE FUN
- HEAT DISSIPATION MATERIAL: ALUMINIUM
- DIMENSIONS: COME ORIGINALE

ART. 40934

**D5S**

**PLUG AND PLAY**  
(CONNETTORE ORIGINALE,  
SENZA MODIFICARE IMPIANTO)

**PARABOLA &  
LENTICOLARE**



### CUSTOM LED HEADLIGHTS SET (2 PCS.)

- PLUG AND PLAY (CONNETTORE ORIGINALE, SENZA MODIFICARE IMPIANTO)
- COLOR: 6000K
- CONTINUOUS POWER: 45W
- MAX OPERATING TEMPERATURE: 90°
- MINIMUM OPERATING TEMPERATURE: -50°
- LUMEN: 6000LM
- HEAT DISSIPATION SYSTEM: TURBINE FUN
- HEAT DISSIPATION MATERIAL: ALUMINIUM
- DIMENSIONS: COME ORIGINALE

ART. 40935

**D8S  
D8R**

**PLUG AND PLAY**  
(CONNETTORE ORIGINALE,  
SENZA MODIFICARE IMPIANTO)

**PARABOLA &  
LENTICOLARE**



### CUSTOM LED HEADLIGHTS SET (2 PCS.)

- PLUG AND PLAY (CONNETTORE ORIGINALE, SENZA MODIFICARE IMPIANTO)
- COLOR: 6000K
- CONTINUOUS POWER: 25W
- MAX OPERATING TEMPERATURE: 90°
- MINIMUM OPERATING TEMPERATURE: -50°
- LUMEN: 6000LM
- HEAT DISSIPATION SYSTEM: TURBINE FUN
- HEAT DISSIPATION MATERIAL: ALUMINIUM
- DIMENSIONS: COME ORIGINALE



# TOP LINE



**12000 LUMEN. IL PIÙ LUMINOSO SUL MERCATO.**

EXTRASMALL, SOLTANTO 7 CENTIMETRI.

VENTOLINA DI RAFFREDDAMENTO SUPER SILENZIOSA.

55 WATT DI ASSORBIMENTO. SUPER CANBUS.



CANBUS

# 12000LM

PER LAMPADA

KIT A LED:  
ANABBAGLIANTI  
ABBAGLIANTI  
FENDINEBBIA

CE RoHS FC

ART. 40402 H7  
ART. 40422 H18



### LED HEADLIGHTS SET (2 PCS.)

- LED POWER: 55W (SINGLE)
- HOUSING MATERIAL: AVIATION ALUMINIUM, RED COPPER
- LAST GENERATION COOLING FAN
- 9-32VOLT DC
- WATERPROOF: IP68
- 12000LM (LUMEN)
- COLOR TEMPERATURE: 6700K
- LIFETIME: >30.000 HOURS
- OPERATING TEMPERATURE: DA -50°C A +90°C
- LIGHT SOURCE MODEL: G-XP X3 CUSTOMIZED

### KIT FARI A LED (COMPOSTO DA 2 PEZZI)

- LED POWER: 55W (SINGLE)
- COMPONENTE LED CHIP DI ELEVATA EFFICIENZA E QUALITÀ, STUDIATO SPECIFICAMENTE PER KIT A LED
- PRODOTTO IN ALLUMINIO
- DOTATO DI VENTOLA DI RAFFREDDAMENTO DI ULTIMA GENERAZIONE
- 9-32VOLT DC
- WATERPROOF: IP68
- 12000LM (LUMEN)
- TEMPERATURA COLORE: 6700K
- LIFETIME: >30.000 ORE
- TEMPERATURA OPERATIVA: DA -50°C A +90°C
- LIGHT SOURCE MODEL: G-XP X3 CUSTOMIZED



ART. 40401 H4  
ART. 40423 H19



### LED HEADLIGHTS SET (2 PCS.)

- LED POWER: 55W (HIGH/LOW)
- HOUSING MATERIAL: AVIATION ALUMINIUM, RED COPPER
- LAST GENERATION COOLING FAN
- 9-32VOLT DC
- WATERPROOF: IP68
- 12000LM (LUMEN)
- COLOR TEMPERATURE: 6700K
- LIFETIME: >30.000 HOURS
- OPERATING TEMPERATURE: DA -50°C A +90°C
- LIGHT SOURCE MODEL: G-XP X3 CUSTOMIZED

### KIT FARI A LED (COMPOSTO DA 2 PEZZI)

- LED POWER: 55W (HIGH/LOW)
- COMPONENTE LED CHIP DI ELEVATA EFFICIENZA E QUALITÀ, STUDIATO SPECIFICAMENTE PER KIT A LED
- PRODOTTO IN ALLUMINIO
- DOTATO DI VENTOLA DI RAFFREDDAMENTO DI ULTIMA GENERAZIONE
- 9-32VOLT DC
- WATERPROOF: IP68
- 12000LM (LUMEN)
- TEMPERATURA COLORE: 6700K
- LIFETIME: >30.000 ORE
- TEMPERATURA OPERATIVA: DA -50°C A +90°C
- LIGHT SOURCE MODEL: G-XP X3 CUSTOMIZED

ART. 40403



### LED HEADLIGHTS SET (2 PCS.)

- LED POWER: 55W (SINGLE)
- HOUSING MATERIAL: AVIATION ALUMINIUM, RED COPPER
- LAST GENERATION COOLING FAN
- 9-32VOLT DC
- WATERPROOF: IP68
- 12000LM (LUMEN)
- COLOR TEMPERATURE: 6700K
- LIFETIME: >30.000 HOURS
- OPERATING TEMPERATURE: DA -50°C A +90°C
- LIGHT SOURCE MODEL: G-XP X3 CUSTOMIZED

### KIT FARI A LED (COMPOSTO DA 2 PEZZI)

- LED POWER: 55W (SINGLE)
- COMPONENTE LED CHIP DI ELEVATA EFFICIENZA E QUALITÀ, STUDIATO SPECIFICAMENTE PER KIT A LED
- PRODOTTO IN ALLUMINIO
- DOTATO DI VENTOLA DI RAFFREDDAMENTO DI ULTIMA GENERAZIONE
- 9-32VOLT DC
- WATERPROOF: IP68
- 12000LM (LUMEN)
- TEMPERATURA COLORE: 6700K
- LIFETIME: >30.000 ORE
- TEMPERATURA OPERATIVA: DA -50°C A +90°C
- LIGHT SOURCE MODEL: G-XP X3 CUSTOMIZED

ART. 40406



### LED HEADLIGHTS SET (2 PCS.)

- LED POWER: 55W (SINGLE)
- HOUSING MATERIAL: AVIATION ALUMINIUM, RED COPPER
- LAST GENERATION COOLING FAN
- 9-32VOLT DC
- WATERPROOF: IP68
- 12000LM (LUMEN)
- COLOR TEMPERATURE: 6700K
- LIFETIME: >30.000 HOURS
- OPERATING TEMPERATURE: DA -50°C A +90°C
- LIGHT SOURCE MODEL: G-XP X3 CUSTOMIZED

### KIT FARI A LED (COMPOSTO DA 2 PEZZI)

- LED POWER: 55W (SINGLE)
- COMPONENTE LED CHIP DI ELEVATA EFFICIENZA E QUALITÀ, STUDIATO SPECIFICAMENTE PER KIT A LED
- PRODOTTO IN ALLUMINIO
- DOTATO DI VENTOLA DI RAFFREDDAMENTO DI ULTIMA GENERAZIONE
- 9-32VOLT DC
- WATERPROOF: IP68
- 12000LM (LUMEN)
- TEMPERATURA COLORE: 6700K
- LIFETIME: >30.000 ORE
- TEMPERATURA OPERATIVA: DA -50°C A +90°C
- LIGHT SOURCE MODEL: G-XP X3 CUSTOMIZED





**GOLD LINE**

**GOLD LINE**



**GOLD LINE**

IL KIT A LED DELLA SERIE GOLD RAPPRESENTA L'ULTIMA TECNOLOGIA DEL LED CAR LIGHTING. INNOVATIVA VENTOLA DI RAFFREDDAMENTO.

**9000 LUMEN PER LAMPADA**



**INNOVATIVA VENTOLA DI RAFFREDDAMENTO**

**48 WATT CAN BUS ULTIMA GENERAZIONE**

**ALUMINUM LIGHT BODY**



ART. 40702

H7



**LED HEADLIGHTS SET (2 PCS.)**

- LED POWER: 48W (SINGLE)
- HOUSING MATERIAL: AVIATION ALUMINIUM, RED COPPER
- EQUIPPED WITH LATEST GENERATION FAN FOR TOTAL HEAT DISSIPATION
- 9-32VOLT DC
- WATERPROOF: IP68
- 9000LM (LUMEN)
- COLOR TEMPERATURE: 6000K
- LIFETIME: >30.000 HOURS
- OPERATING TEMPERATURE: DA -50°C A +90°C
- 9-32VOLT DC
- WATERPROOF: IP68
- 9000LM (LUMEN)
- TEMPERATURA COLORE: 6000K
- LIFETIME: >30.000 ORE
- TEMPERATURA OPERATIVA: DA -50°C A +90°C

ART. 40701

H4



**LED HEADLIGHTS SET (2 PCS.)**

- 48W/36W (HIGH/LOW)
- HOUSING MATERIAL: AVIATION ALUMINIUM, RED COPPER
- EQUIPPED WITH LATEST GENERATION FAN FOR TOTAL HEAT DISSIPATION
- 9-32VOLT DC
- WATERPROOF: IP68
- 9000LM (LUMEN)
- COLOR TEMPERATURE: 6000K
- LIFETIME: >30.000 HOURS
- OPERATING TEMPERATURE: DA -50°C A +90°C
- 48W/36W (HIGH/LOW)
- COMPONENTE LED CHIP DI ELEVATA EFFICIENZA E QUALITÀ, STUDIATO SPECIFICAMENTE PER KIT A LED
- PRODOTTO IN ALLUMINIO
- DOTATO DI VENTOLA ULTIMA GENERAZIONE PER LA DISSIPAZIONE TOTALE DEL CALORE
- 9-32VOLT DC
- WATERPROOF: IP68
- 9000LM (LUMEN)
- TEMPERATURA COLORE: 6000K
- LIFETIME: >30.000 ORE
- TEMPERATURA OPERATIVA: DA -50°C A +90°C

ART. 40703

H8-H9-H11



**LED HEADLIGHTS SET (2 PCS.)**

- LED POWER: 48W (SINGLE)
- HOUSING MATERIAL: AVIATION ALUMINIUM, RED COPPER
- EQUIPPED WITH LATEST GENERATION FAN FOR TOTAL HEAT DISSIPATION
- 9-32VOLT DC
- WATERPROOF: IP68
- 9000LM (LUMEN)
- COLOR TEMPERATURE: 6000K
- LIFETIME: >30.000 HOURS
- OPERATING TEMPERATURE: DA -50°C A +90°C
- LED POWER: 48W (SINGLE)
- COMPONENTE LED CHIP DI ELEVATA EFFICIENZA E QUALITÀ, STUDIATO SPECIFICAMENTE PER KIT A LED
- PRODOTTO IN ALLUMINIO
- DOTATO DI VENTOLA ULTIMA GENERAZIONE PER LA DISSIPAZIONE TOTALE DEL CALORE
- 9-32VOLT DC
- WATERPROOF: IP68
- 9000LM (LUMEN)
- TEMPERATURA COLORE: 6000K
- LIFETIME: >30.000 ORE
- TEMPERATURA OPERATIVA: DA -50°C A +90°C

ART. 40704

HB3 - 9005



**LED HEADLIGHTS SET (2 PCS.)**

- LED POWER: 48W (SINGLE)
- HOUSING MATERIAL: AVIATION ALUMINIUM, RED COPPER
- EQUIPPED WITH LATEST GENERATION FAN FOR TOTAL HEAT DISSIPATION
- 9-32VOLT DC
- WATERPROOF: IP68
- 9000LM (LUMEN)
- COLOR TEMPERATURE: 6000K
- LIFETIME: >30.000 HOURS
- OPERATING TEMPERATURE: DA -50°C A +90°C
- LED POWER: 48W (SINGLE)
- COMPONENTE LED CHIP DI ELEVATA EFFICIENZA E QUALITÀ, STUDIATO SPECIFICAMENTE PER KIT A LED
- PRODOTTO IN ALLUMINIO
- DOTATO DI VENTOLA ULTIMA GENERAZIONE PER LA DISSIPAZIONE TOTALE DEL CALORE
- 9-32VOLT DC
- WATERPROOF: IP68
- 9000LM (LUMEN)
- TEMPERATURA COLORE: 6000K
- LIFETIME: >30.000 ORE
- TEMPERATURA OPERATIVA: DA -50°C A +90°C







## PLUG AND PLAY

ART. 40604

HB3-9005



### LED HEADLIGHTS SET PLUG AND PLAY (2 PCS.)

- LED POWER: 27W (SINGLE)
- HOUSING MATERIAL: AVIATION ALUMINIUM, RED COPPER
- HEAT DISSIPATION
- DC 6V-32V
- INPUT 1.2A±0.1A
- WATERPROOF: IP68
- 5200LM (LUMEN)
- COLOR TEMPERATURE: 5700K
- LIFETIME: >30.000 HOURS
- OPERATING TEMPERATURE: DA -50°C A +90°C
- BEAM ANGLE: 360°

### KIT FARI A LED PLUG AND PLAY (COMPOSTO DA 2 PEZZI)

- LED POWER: 27W (SINGLE)
- COMPONENTE LED CHIP DI ELEVATA EFFICIENZA E QUALITÀ, STUDIATO SPECIFICAMENTE PER KIT A LED
- PRODOTTO IN ALLUMINIO
- DOTATO DI DISSIPATORE DEL CALORE
- DC 6V-32V
- INPUT 1.2A±0.1A
- WATERPROOF: IP68
- 5200LM (LUMEN)
- TEMPERATURA COLORE: 5700K
- LIFETIME: >30.000 ORE
- TEMPERATURA OPERATIVA: DA -50°C A +90°C
- ANGOLO FASCIO D'ILLUMINAZIONE REGOLABILE A 360°

ART. 40605

HIR2-9012



### LED HEADLIGHTS SET PLUG AND PLAY (2 PCS.)

- LED POWER: 27W (SINGLE)
- HOUSING MATERIAL: AVIATION ALUMINIUM, RED COPPER
- HEAT DISSIPATION
- DC 6V-32V
- INPUT 1.2A±0.1A
- WATERPROOF: IP68
- 5200LM (LUMEN)
- COLOR TEMPERATURE: 5700K
- LIFETIME: >30.000 HOURS
- OPERATING TEMPERATURE: DA -50°C A +90°C
- BEAM ANGLE: 360°

### KIT FARI A LED PLUG AND PLAY (COMPOSTO DA 2 PEZZI)

- LED POWER: 27W (SINGLE)
- COMPONENTE LED CHIP DI ELEVATA EFFICIENZA E QUALITÀ, STUDIATO SPECIFICAMENTE PER KIT A LED
- PRODOTTO IN ALLUMINIO
- DOTATO DI DISSIPATORE DEL CALORE
- DC 6V-32V
- INPUT 1.2A±0.1A
- WATERPROOF: IP68
- 5200LM (LUMEN)
- TEMPERATURA COLORE: 5700K
- LIFETIME: >30.000 ORE
- TEMPERATURA OPERATIVA: DA -50°C A +90°C
- ANGOLO FASCIO D'ILLUMINAZIONE REGOLABILE A 360°

ART. 40608



### LED HEADLIGHTS SET PLUG AND PLAY (2 PCS.)

- LED POWER: 27W (HIGH/LOW)
- HOUSING MATERIAL: AVIATION ALUMINIUM, RED COPPER
- HEAT DISSIPATION
- DC 6V-32V
- INPUT 1.2A±0.1A
- WATERPROOF: IP68
- 5200LM (LUMEN)
- COLOR TEMPERATURE: 5700K
- LIFETIME: >30.000 HOURS
- OPERATING TEMPERATURE: DA -50°C A +90°C
- BEAM ANGLE: 360°

### KIT FARI A LED PLUG AND PLAY (COMPOSTO DA 2 PEZZI)

- LED POWER: 27W (HIGH/LOW)
- COMPONENTE LED CHIP DI ELEVATA EFFICIENZA E QUALITÀ, STUDIATO SPECIFICAMENTE PER KIT A LED
- PRODOTTO IN ALLUMINIO
- DOTATO DI DISSIPATORE DEL CALORE
- DC 6V-32V
- INPUT 1.2A±0.1A
- WATERPROOF: IP68
- 5200LM (LUMEN)
- TEMPERATURA COLORE: 5700K
- LIFETIME: >30.000 ORE
- TEMPERATURA OPERATIVA: DA -50°C A +90°C
- ANGOLO FASCIO D'ILLUMINAZIONE REGOLABILE A 360°

## PLUG AND PLAY

ART. 40607

HB4-9006



### LED HEADLIGHTS SET PLUG AND PLAY (2 PCS.)

- LED POWER: 27W (SINGLE)
- HOUSING MATERIAL: AVIATION ALUMINIUM, RED COPPER
- HEAT DISSIPATION
- DC 6V-32V
- INPUT 1.2A±0.1A
- WATERPROOF: IP68
- 5200LM (LUMEN)
- COLOR TEMPERATURE: 5700K
- LIFETIME: >30.000 HOURS
- OPERATING TEMPERATURE: DA -50°C A +90°C
- BEAM ANGLE: 360°

### KIT FARI A LED PLUG AND PLAY (COMPOSTO DA 2 PEZZI)

- LED POWER: 27W (SINGLE)
- COMPONENTE LED CHIP DI ELEVATA EFFICIENZA E QUALITÀ, STUDIATO SPECIFICAMENTE PER KIT A LED
- PRODOTTO IN ALLUMINIO
- DOTATO DI DISSIPATORE DEL CALORE
- DC 6V-32V
- INPUT 1.2A±0.1A
- WATERPROOF: IP68
- 5200LM (LUMEN)
- TEMPERATURA COLORE: 5700K
- LIFETIME: >30.000 ORE
- TEMPERATURA OPERATIVA: DA -50°C A +90°C
- ANGOLO FASCIO D'ILLUMINAZIONE REGOLABILE A 360°

ART. 40606

H1



### LED HEADLIGHTS SET PLUG AND PLAY (2 PCS.)

- LED POWER: 27W (SINGLE)
- HOUSING MATERIAL: AVIATION ALUMINIUM, RED COPPER
- HEAT DISSIPATION
- DC 6V-32V
- INPUT 1.2A±0.1A
- WATERPROOF: IP68
- 5200LM (LUMEN)
- COLOR TEMPERATURE: 5700K
- LIFETIME: >30.000 HOURS
- OPERATING TEMPERATURE: DA -50°C A +90°C
- BEAM ANGLE: 360°

### KIT FARI A LED PLUG AND PLAY (COMPOSTO DA 2 PEZZI)

- LED POWER: 27W (SINGLE)
- COMPONENTE LED CHIP DI ELEVATA EFFICIENZA E QUALITÀ, STUDIATO SPECIFICAMENTE PER KIT A LED
- PRODOTTO IN ALLUMINIO
- DOTATO DI DISSIPATORE DEL CALORE
- DC 6V-32V
- INPUT 1.2A±0.1A
- WATERPROOF: IP68
- 5200LM (LUMEN)
- TEMPERATURA COLORE: 5700K
- LIFETIME: >30.000 ORE
- TEMPERATURA OPERATIVA: DA -50°C A +90°C
- ANGOLO FASCIO D'ILLUMINAZIONE REGOLABILE A 360°

ART. 40609

H3



### LED HEADLIGHTS SET PLUG AND PLAY (2 PCS.)

- LED POWER: 27W (SINGLE)
- HOUSING MATERIAL: AVIATION ALUMINIUM, RED COPPER
- HEAT DISSIPATION
- DC 6V-32V
- INPUT 1.2A±0.1A
- WATERPROOF: IP68
- 5200LM (LUMEN)
- COLOR TEMPERATURE: 5700K
- LIFETIME: >30.000 HOURS
- OPERATING TEMPERATURE: DA -50°C A +90°C
- BEAM ANGLE: 360°

### KIT FARI A LED PLUG AND PLAY (COMPOSTO DA 2 PEZZI)

- LED POWER: 27W (SINGLE)
- COMPONENTE LED CHIP DI ELEVATA EFFICIENZA E QUALITÀ, STUDIATO SPECIFICAMENTE PER KIT A LED
- PRODOTTO IN ALLUMINIO
- DOTATO DI DISSIPATORE DEL CALORE
- DC 6V-32V
- INPUT 1.2A±0.1A
- WATERPROOF: IP68
- 5200LM (LUMEN)
- TEMPERATURA COLORE: 5700K
- LIFETIME: >30.000 ORE
- TEMPERATURA OPERATIVA: DA -50°C A +90°C
- ANGOLO FASCIO D'ILLUMINAZIONE REGOLABILE A 360°

**EXTRA SMALL  
CON VENTOLA (LA PIÙ PICCOLA SUL MERCATO)**

IL KIT A LED DELLA SERIE SMALL LINE È DI DIMENSIONI ESTREMAMENTE CONTENUTE E PERTANTO LA SUA INSTALLAZIONE RISULTA POSSIBILE ANCHE DOVE LO SPAZIO È RIDOTTO. INSTALLAZIONE PLUG AND PLAY.



**SMALL SIZE ONLY 7 CM  
DIMENSIONI RIDOTTE SOLO 7 CM**

**NO ERROR**

**LUCE FREDDA 6000K**

**HEAT DISSIPATION FAST  
RAFFREDDAMENTO VELOCE**

**6500  
LUMEN  
PER LAMPADA**

**PLUG AND PLAY**

**ADJUSTABLE  
360° BEAM ANGLE  
ANGOLO FASCIO DI  
LUCE REGOLABILE 360°**

ART. 40852



H7

**LED HEADLIGHTS SET SMALL LINE (2 PCS.)**

- LED POWER: 35W (SINGLE)
- HOUSING MATERIAL: AVIATION ALUMINIUM 6063
- DUAL FAN SYSTEM HEAT DISSIPATION
- DC 9V-32V
- WATERPROOF: IP67
- 6500LM (LUMEN)
- COLOR TEMPERATURE: 6000K
- LIFETIME: >30.000 HOURS
- OPERATING TEMPERATURE: DA -40°C A +80°C
- BEAM ANGLE: 360°

- LED POWER: 35W (SINGLE)
- COMPONENTE LED CHIP DI ELEVATA EFFICIENZA E QUALITÀ, STUDIATO SPECIFICAMENTE PER KIT A LED
- PRODOTTO IN ALLUMINIO 6063
- DOPPIO DISSIPATORE DEL CALORE CON VENTOLA
- DC 9V-32V
- WATERPROOF: IP67
- 6500LM (LUMEN)
- TEMPERATURA COLORE: 6000K
- LIFETIME: >30.000 ORE
- TEMPERATURA OPERATIVA: DA -40°C A +80°C
- ANGOLO FASCIO D'ILLUMINAZIONE REGOLABILE A 360°

ART. 40851



H4

**LED HEADLIGHTS SET SMALL LINE (2 PCS.)**

- LED POWER: 35W/35W (HIGH/LOW)
- HOUSING MATERIAL: AVIATION ALUMINIUM 6063
- DUAL FAN SYSTEM HEAT DISSIPATION
- DC 9V-32V
- WATERPROOF: IP67
- 6500LM (LUMEN)
- COLOR TEMPERATURE: 6000K
- LIFETIME: >30.000 HOURS
- OPERATING TEMPERATURE: DA -40°C A +80°C
- BEAM ANGLE: 360°

- LED POWER: 35W/35W (HIGH/LOW)
- COMPONENTE LED CHIP DI ELEVATA EFFICIENZA E QUALITÀ, STUDIATO SPECIFICAMENTE PER KIT A LED
- PRODOTTO IN ALLUMINIO 6063
- DOPPIO DISSIPATORE DEL CALORE CON VENTOLA
- DC 9V-32V
- WATERPROOF: IP67
- 6500LM (LUMEN)
- TEMPERATURA COLORE: 6000K
- LIFETIME: >30.000 ORE
- TEMPERATURA OPERATIVA: DA -40°C A +80°C
- ANGOLO FASCIO D'ILLUMINAZIONE REGOLABILE A 360°

ART. 40853



H11-H8-H9-H16

**LED HEADLIGHTS SET SMALL LINE (2 PCS.)**

- LED POWER: 35W (SINGLE)
- HOUSING MATERIAL: AVIATION ALUMINIUM 6063
- DUAL FAN SYSTEM HEAT DISSIPATION
- DC 9V-32V
- WATERPROOF: IP67
- 6500LM (LUMEN)
- COLOR TEMPERATURE: 6000K
- LIFETIME: >30.000 HOURS
- OPERATING TEMPERATURE: DA -40°C A +80°C
- BEAM ANGLE: 360°

- LED POWER: 35W (SINGLE)
- COMPONENTE LED CHIP DI ELEVATA EFFICIENZA E QUALITÀ, STUDIATO SPECIFICAMENTE PER KIT A LED
- PRODOTTO IN ALLUMINIO 6063
- DOPPIO DISSIPATORE DEL CALORE CON VENTOLA
- DC 9V-32V
- WATERPROOF: IP67
- 6500LM (LUMEN)
- TEMPERATURA COLORE: 6000K
- LIFETIME: >30.000 ORE
- TEMPERATURA OPERATIVA: DA -40°C A +80°C
- ANGOLO FASCIO D'ILLUMINAZIONE REGOLABILE A 360°

ART. 40854



HB3-9005

**LED HEADLIGHTS SET SMALL LINE (2 PCS.)**

- LED POWER: 35W (SINGLE)
- HOUSING MATERIAL: AVIATION ALUMINIUM 6063
- DUAL FAN SYSTEM HEAT DISSIPATION
- DC 9V-32V
- WATERPROOF: IP67
- 6500LM (LUMEN)
- COLOR TEMPERATURE: 6000K
- LIFETIME: >30.000 HOURS
- OPERATING TEMPERATURE: DA -40°C A +80°C
- BEAM ANGLE: 360°

- LED POWER: 35W (SINGLE)
- COMPONENTE LED CHIP DI ELEVATA EFFICIENZA E QUALITÀ, STUDIATO SPECIFICAMENTE PER KIT A LED
- PRODOTTO IN ALLUMINIO 6063
- DOPPIO DISSIPATORE DEL CALORE CON VENTOLA
- DC 9V-32V
- WATERPROOF: IP67
- 6500LM (LUMEN)
- TEMPERATURA COLORE: 6000K
- LIFETIME: >30.000 ORE
- TEMPERATURA OPERATIVA: DA -40°C A +80°C
- ANGOLO FASCIO D'ILLUMINAZIONE REGOLABILE A 360°

ART. 40857



HB4-9006

**LED HEADLIGHTS SET SMALL LINE (2 PCS.)**

- LED POWER: 35W (SINGLE)
- HOUSING MATERIAL: AVIATION ALUMINIUM 6063
- DUAL FAN SYSTEM HEAT DISSIPATION
- DC 9V-32V
- WATERPROOF: IP67
- 6500LM (LUMEN)
- COLOR TEMPERATURE: 6000K
- LIFETIME: >30.000 HOURS
- OPERATING TEMPERATURE: DA -40°C A +80°C
- BEAM ANGLE: 360°

- LED POWER: 35W (SINGLE)
- COMPONENTE LED CHIP DI ELEVATA EFFICIENZA E QUALITÀ, STUDIATO SPECIFICAMENTE PER KIT A LED
- PRODOTTO IN ALLUMINIO 6063
- DOPPIO DISSIPATORE DEL CALORE CON VENTOLA
- DC 9V-32V
- WATERPROOF: IP67
- 6500LM (LUMEN)
- TEMPERATURA COLORE: 6000K
- LIFETIME: >30.000 ORE
- TEMPERATURA OPERATIVA: DA -40°C A +80°C
- ANGOLO FASCIO D'ILLUMINAZIONE REGOLABILE A 360°

ART. 40855



HIR2-9012

**LED HEADLIGHTS SET SMALL LINE (2 PCS.)**

- LED POWER: 35W (SINGLE)
- HOUSING MATERIAL: AVIATION ALUMINIUM 6063
- DUAL FAN SYSTEM HEAT DISSIPATION
- DC 9V-32V
- WATERPROOF: IP67
- 6500LM (LUMEN)
- COLOR TEMPERATURE: 6000K
- LIFETIME: >30.000 HOURS
- OPERATING TEMPERATURE: DA -40°C A +80°C
- BEAM ANGLE: 360°

- LED POWER: 35W (SINGLE)
- COMPONENTE LED CHIP DI ELEVATA EFFICIENZA E QUALITÀ, STUDIATO SPECIFICAMENTE PER KIT A LED
- PRODOTTO IN ALLUMINIO 6063
- DOPPIO DISSIPATORE DEL CALORE CON VENTOLA
- DC 9V-32V
- WATERPROOF: IP67
- 6500LM (LUMEN)
- TEMPERATURA COLORE: 6000K
- LIFETIME: >30.000 ORE
- TEMPERATURA OPERATIVA: DA -40°C A +80°C
- ANGOLO FASCIO D'ILLUMINAZIONE REGOLABILE A 360°



ART. 40860



H10

**LED HEADLIGHTS SET SMALL LINE [2 PCS.]**

- LED POWER: 35W (SINGLE)
- HOUSING MATERIAL: AVIATION ALUMINIUM 6063
- DUAL FAN SYSTEM HEAT DISSIPATION DC 9V-32V
- WATERPROOF: IP67
- 6500LM (LUMEN)
- COLOR TEMPERATURE: 6000K
- LIFETIME: >30.000 HOURS
- OPERATING TEMPERATURE: DA -40°C A +80°C
- BEAM ANGLE: 360°

- LED POWER: 35W (SINGLE)
- COMPONENTE LED CHIP DI ELEVATA EFFICIENZA E QUALITÀ, STUDIATO SPECIFICAMENTE PER KIT A LED
- PRODOTTO IN ALLUMINIO 6063
- DOPPIO DISSIPATORE DEL CALORE CON VENTOLA
- DC 9V-32V
- WATERPROOF: IP67
- 6500LM (LUMEN)
- TEMPERATURA COLORE: 6000K
- LIFETIME: >30.000 ORE
- TEMPERATURA OPERATIVA: DA -40°C A +80°C
- ANGOLO FASCIO D'ILLUMINAZIONE REGOLABILE A 360°

ART. 40856



H1

**LED HEADLIGHTS SET SMALL LINE [2 PCS.]**

- LED POWER: 35W (SINGLE)
- HOUSING MATERIAL: AVIATION ALUMINIUM 6063
- DUAL FAN SYSTEM HEAT DISSIPATION DC 9V-32V
- WATERPROOF: IP67
- 6500LM (LUMEN)
- COLOR TEMPERATURE: 6000K
- LIFETIME: >30.000 HOURS
- OPERATING TEMPERATURE: DA -40°C A +80°C
- BEAM ANGLE: 360°

- LED POWER: 35W (SINGLE)
- COMPONENTE LED CHIP DI ELEVATA EFFICIENZA E QUALITÀ, STUDIATO SPECIFICAMENTE PER KIT A LED
- PRODOTTO IN ALLUMINIO 6063
- DOPPIO DISSIPATORE DEL CALORE CON VENTOLA
- DC 9V-32V
- WATERPROOF: IP67
- 6500LM (LUMEN)
- TEMPERATURA COLORE: 6000K
- LIFETIME: >30.000 ORE
- TEMPERATURA OPERATIVA: DA -40°C A +80°C
- ANGOLO FASCIO D'ILLUMINAZIONE REGOLABILE A 360°

ART. 40859



H3

**LED HEADLIGHTS SET SMALL LINE [2 PCS.]**

- LED POWER: 35W (SINGLE)
- HOUSING MATERIAL: AVIATION ALUMINIUM 6063
- DUAL FAN SYSTEM HEAT DISSIPATION DC 9V-32V
- WATERPROOF: IP67
- 6500LM (LUMEN)
- COLOR TEMPERATURE: 6000K
- LIFETIME: >30.000 HOURS
- OPERATING TEMPERATURE: DA -40°C A +80°C
- BEAM ANGLE: 360°

- LED POWER: 35W (SINGLE)
- COMPONENTE LED CHIP DI ELEVATA EFFICIENZA E QUALITÀ, STUDIATO SPECIFICAMENTE PER KIT A LED
- PRODOTTO IN ALLUMINIO 6063
- DOPPIO DISSIPATORE DEL CALORE CON VENTOLA
- DC 9V-32V
- WATERPROOF: IP67
- 6500LM (LUMEN)
- TEMPERATURA COLORE: 6000K
- LIFETIME: >30.000 ORE
- TEMPERATURA OPERATIVA: DA -40°C A +80°C
- ANGOLO FASCIO D'ILLUMINAZIONE REGOLABILE A 360°

ART. 40871



P13W-PSX26W

**LED HEADLIGHTS SET SMALL LINE [2 PCS.]**

- LED POWER: 35W (SINGLE)
- HOUSING MATERIAL: AVIATION ALUMINIUM 6063
- DUAL FAN SYSTEM HEAT DISSIPATION DC 9V-32V
- WATERPROOF: IP67
- 6500LM (LUMEN)
- COLOR TEMPERATURE: 6000K
- LIFETIME: >30.000 HOURS
- OPERATING TEMPERATURE: DA -40°C A +80°C
- BEAM ANGLE: 360°

- LED POWER: 35W (SINGLE)
- COMPONENTE LED CHIP DI ELEVATA EFFICIENZA E QUALITÀ, STUDIATO SPECIFICAMENTE PER KIT A LED
- PRODOTTO IN ALLUMINIO 6063
- DOPPIO DISSIPATORE DEL CALORE CON VENTOLA
- DC 9V-32V
- WATERPROOF: IP67
- 6500LM (LUMEN)
- TEMPERATURA COLORE: 6000K
- LIFETIME: >30.000 ORE
- TEMPERATURA OPERATIVA: DA -40°C A +80°C
- ANGOLO FASCIO D'ILLUMINAZIONE REGOLABILE A 360°

ART. 40869



PSX24W-5202

**LED HEADLIGHTS SET SMALL LINE [2 PCS.]**

- LED POWER: 35W (SINGLE)
- HOUSING MATERIAL: AVIATION ALUMINIUM 6063
- DUAL FAN SYSTEM HEAT DISSIPATION DC 9V-32V
- WATERPROOF: IP67
- 6500LM (LUMEN)
- COLOR TEMPERATURE: 6000K
- LIFETIME: >30.000 HOURS
- OPERATING TEMPERATURE: DA -40°C A +80°C
- BEAM ANGLE: 360°

- LED POWER: 35W (SINGLE)
- COMPONENTE LED CHIP DI ELEVATA EFFICIENZA E QUALITÀ, STUDIATO SPECIFICAMENTE PER KIT A LED
- PRODOTTO IN ALLUMINIO 6063
- DOPPIO DISSIPATORE DEL CALORE CON VENTOLA
- DC 9V-32V
- WATERPROOF: IP67
- 6500LM (LUMEN)
- TEMPERATURA COLORE: 6000K
- LIFETIME: >30.000 ORE
- TEMPERATURA OPERATIVA: DA -40°C A +80°C
- ANGOLO FASCIO D'ILLUMINAZIONE REGOLABILE A 360°

ART. 40861



H27-880-881

**LED HEADLIGHTS SET SMALL LINE [2 PCS.]**

- LED POWER: 35W (SINGLE)
- HOUSING MATERIAL: AVIATION ALUMINIUM 6063
- DUAL FAN SYSTEM HEAT DISSIPATION DC 9V-32V
- WATERPROOF: IP67
- 6500LM (LUMEN)
- COLOR TEMPERATURE: 6000K
- LIFETIME: >30.000 HOURS
- OPERATING TEMPERATURE: DA -40°C A +80°C
- BEAM ANGLE: 360°

- LED POWER: 35W (SINGLE)
- COMPONENTE LED CHIP DI ELEVATA EFFICIENZA E QUALITÀ, STUDIATO SPECIFICAMENTE PER KIT A LED
- PRODOTTO IN ALLUMINIO 6063
- DOPPIO DISSIPATORE DEL CALORE CON VENTOLA
- DC 9V-32V
- WATERPROOF: IP67
- 6500LM (LUMEN)
- TEMPERATURA COLORE: 6000K
- LIFETIME: >30.000 ORE
- TEMPERATURA OPERATIVA: DA -40°C A +80°C
- ANGOLO FASCIO D'ILLUMINAZIONE REGOLABILE A 360°

ART. 40863



H13-9008

**LED HEADLIGHTS SET SMALL LINE [2 PCS.]**

- LED POWER: 35W/35W (HIGH/LOW)
- HOUSING MATERIAL: AVIATION ALUMINIUM 6063
- DUAL FAN SYSTEM HEAT DISSIPATION DC 9V-32V
- WATERPROOF: IP67
- 6500LM (LUMEN)
- COLOR TEMPERATURE: 6000K
- LIFETIME: >30.000 HOURS
- OPERATING TEMPERATURE: DA -40°C A +80°C
- BEAM ANGLE: 360°

- LED POWER: 35W/35W (HIGH/LOW)
- COMPONENTE LED CHIP DI ELEVATA EFFICIENZA E QUALITÀ, STUDIATO SPECIFICAMENTE PER KIT A LED
- PRODOTTO IN ALLUMINIO 6063
- DOPPIO DISSIPATORE DEL CALORE CON VENTOLA
- DC 9V-32V
- WATERPROOF: IP67
- 6500LM (LUMEN)
- TEMPERATURA COLORE: 6000K
- LIFETIME: >30.000 ORE
- TEMPERATURA OPERATIVA: DA -40°C A +80°C
- ANGOLO FASCIO D'ILLUMINAZIONE REGOLABILE A 360°

ART. 40865



HB1-9004

**LED HEADLIGHTS SET SMALL LINE [2 PCS.]**

- LED POWER: 35W/35W (HIGH/LOW)
- HOUSING MATERIAL: AVIATION ALUMINIUM 6063
- DUAL FAN SYSTEM HEAT DISSIPATION DC 9V-32V
- WATERPROOF: IP67
- 6500LM (LUMEN)
- COLOR TEMPERATURE: 6000K
- LIFETIME: >30.000 HOURS
- OPERATING TEMPERATURE: DA -40°C A +80°C
- BEAM ANGLE: 360°

- LED POWER: 35W/35W (HIGH/LOW)
- COMPONENTE LED CHIP DI ELEVATA EFFICIENZA E QUALITÀ, STUDIATO SPECIFICAMENTE PER KIT A LED
- PRODOTTO IN ALLUMINIO 6063
- DOPPIO DISSIPATORE DEL CALORE CON VENTOLA
- DC 9V-32V
- WATERPROOF: IP67
- 6500LM (LUMEN)
- TEMPERATURA COLORE: 6000K
- LIFETIME: >30.000 ORE
- TEMPERATURA OPERATIVA: DA -40°C A +80°C
- ANGOLO FASCIO D'ILLUMINAZIONE REGOLABILE A 360°

**PLUG AND PLAY  
SHORT LINE**

**STESSE DIMENSIONI DELL'ORIGINALE  
NON NECESSITA DI ADATTATORI**



H7

**ART. 40582 - H7 (1 COPPIA)**



H7

**6000 LUMEN  
PER LAMPADA**

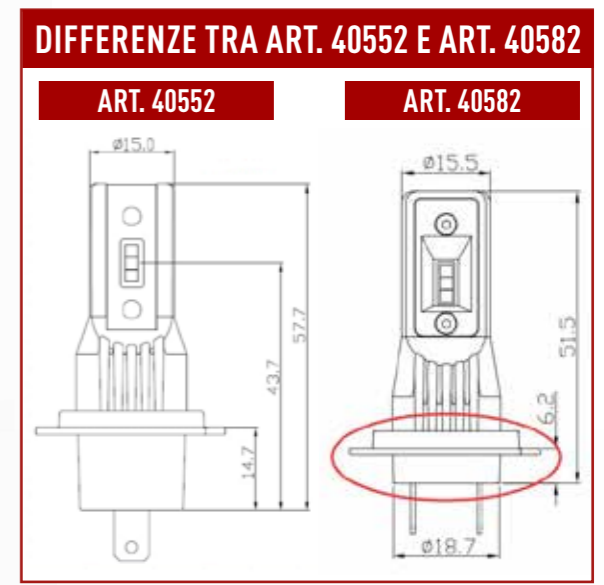

**ALUMINIUM  
LIGHT BOY**

**PLUG AND PLAY**

**12 V - 35 WATT**

**LUCE BIANCA  
6000 K**





# PLUG AND PLAY ENTRY LEVEL

KIT A LED DI SEMPLICE INSTALLAZIONE GRAZIE ALLA TECNOLOGIA PLUG AND PLAY.  
IL KIT A LED PRO PUÒ ESSERE UTILIZZATO PER GLI ANABBAGLIANTI  
E SOPRATTUTTO PER FENDINEBBIA ED ABBAGLIANTI GRAZIE ALLA SUA  
PRATICITÀ DI UTILIZZO.



**4500 LUMEN  
PER LAMPADA**

**SMALL SIZE  
DIMENSIONI  
RIDOTTE**

**ALUMINUM  
LIGHT BODY**

**PLUG AND PLAY**

ART. 40552



**KIT FARI A LED PLUG AND PLAY** (COMPOSTO DA 2 PEZZI)

- LED POWER: 30W (SINGLE)
- COMPONENTE LED CHIP DI ELEVATA EFFICIENZA E QUALITÀ, STUDIATO SPECIFICAMENTE PER KIT A LED
- PRODOTTO IN ALLUMINIO
- DOTATO DI DISSIPATORE DEL CALORE
- DC 9V-16V
- INPUT 1.2A±0.1A
- WATERPROOF: IP67
- 4500LM (LUMEN)
- TEMPERATURA COLORE: 6000K
- LIFETIME: >10.000 ORE
- TEMPERATURA OPERATIVA: DA -50°C A +90°C

ART. 40551



**KIT FARI A LED PLUG AND PLAY** (COMPOSTO DA 2 PEZZI)

- LED POWER: 30W (HIGH/LOW)
- COMPONENTE LED CHIP DI ELEVATA EFFICIENZA E QUALITÀ, STUDIATO SPECIFICAMENTE PER KIT A LED
- PRODOTTO IN ALLUMINIO
- DOTATO DI DISSIPATORE DEL CALORE
- DC 9V-16V
- INPUT 1.2A±0.1A
- WATERPROOF: IP67
- 4500LM (LUMEN)
- TEMPERATURA COLORE: 6000K
- LIFETIME: >10.000 ORE
- TEMPERATURA OPERATIVA: DA -50°C A +90°C

ART. 40553

H11-H8-H9



**KIT FARI A LED PLUG AND PLAY** (COMPOSTO DA 2 PEZZI)

- LED POWER: 30W (SINGLE)
- COMPONENTE LED CHIP DI ELEVATA EFFICIENZA E QUALITÀ, STUDIATO SPECIFICAMENTE PER KIT A LED
- PRODOTTO IN ALLUMINIO
- DOTATO DI DISSIPATORE DEL CALORE
- DC 9V-16V
- INPUT 1.2A±0.1A
- WATERPROOF: IP67
- 4500LM (LUMEN)
- TEMPERATURA COLORE: 6000K
- LIFETIME: >10.000 ORE
- TEMPERATURA OPERATIVA: DA -50°C A +90°C

ART. 40556

H1



**KIT FARI A LED PLUG AND PLAY** (COMPOSTO DA 2 PEZZI)

- LED POWER: 30W (SINGLE)
- COMPONENTE LED CHIP DI ELEVATA EFFICIENZA E QUALITÀ, STUDIATO SPECIFICAMENTE PER KIT A LED
- PRODOTTO IN ALLUMINIO
- DOTATO DI DISSIPATORE DEL CALORE
- DC 9V-16V
- INPUT 1.2A±0.1A
- WATERPROOF: IP67
- 4500LM (LUMEN)
- TEMPERATURA COLORE: 6000K
- LIFETIME: >10.000 ORE
- TEMPERATURA OPERATIVA: DA -50°C A +90°C

ART. 40554

HB3-9005



**KIT FARI A LED PLUG AND PLAY** (COMPOSTO DA 2 PEZZI)

- LED POWER: 30W (SINGLE)
- COMPONENTE LED CHIP DI ELEVATA EFFICIENZA E QUALITÀ, STUDIATO SPECIFICAMENTE PER KIT A LED
- PRODOTTO IN ALLUMINIO
- DOTATO DI DISSIPATORE DEL CALORE
- DC 9V-16V
- INPUT 1.2A±0.1A
- WATERPROOF: IP67
- 4500LM (LUMEN)
- TEMPERATURA COLORE: 6000K
- LIFETIME: >10.000 ORE
- TEMPERATURA OPERATIVA: DA -50°C A +90°C

ART. 40559

H3



**KIT FARI A LED PLUG AND PLAY** (COMPOSTO DA 2 PEZZI)

- LED POWER: 30W (SINGLE)
- COMPONENTE LED CHIP DI ELEVATA EFFICIENZA E QUALITÀ, STUDIATO SPECIFICAMENTE PER KIT A LED
- PRODOTTO IN ALLUMINIO
- DOTATO DI DISSIPATORE DEL CALORE
- DC 9V-16V
- INPUT 1.2A±0.1A
- WATERPROOF: IP67
- 4500LM (LUMEN)
- TEMPERATURA COLORE: 6000K
- LIFETIME: >10.000 ORE
- TEMPERATURA OPERATIVA: DA -50°C A +90°C

ART. 40558

H15



**KIT FARI A LED PLUG AND PLAY** (COMPOSTO DA 2 PEZZI)

- LED POWER: 30W (HIGH/LOW)
- COMPONENTE LED CHIP DI ELEVATA EFFICIENZA E QUALITÀ, STUDIATO SPECIFICAMENTE PER KIT A LED
- PRODOTTO IN ALLUMINIO
- DOTATO DI DISSIPATORE DEL CALORE
- DC 9V-16V
- INPUT 1.2A±0.1A
- WATERPROOF: IP67
- 4500LM (LUMEN)
- TEMPERATURA COLORE: 6000K
- LIFETIME: >10.000 ORE
- TEMPERATURA OPERATIVA: DA -50°C A +90°C

# EXTRA SMALL

IL KIT A LED DELLA SERIE SMALL LINE È DI DIMENSIONI ESTREMAMENTE CONTENUTE E PERTANTO LA SUA INSTALLAZIONE RISULTA POSSIBILE ANCHE DOVE LO SPAZIO È RIDOTTO. INSTALLAZIONE PLUG AND PLAY.



**SMALL SIZE ONLY 7 CM**  
**DIMENSIONI RIDOTTE SOLO 7 CM**

**HEAT DISSIPATION FAST**  
**RAFFREDDAMENTO VELOCE**

**SUPER CAN BUS**

**ADJUSTABLE**  
**360° BEAM ANGLE**  
**ANGOLO FASCIO DI**  
**LUCE REGOLABILE 360°**

**NO ERROR**

**6000 LUMEN**  
**PER LAMPADA**

**PLUG AND PLAY**

**BRIGHT**  
**SMALL**  
**FAST**

**HIGH BRIGHTNESS LIGHT SOURCES**

Customized CREE multi-core technology

One multi-core technology, 300% higher than original bulb

**HIGH EFFICIENCY SAFETY**

360 degrees adjustable socket

15 degrees

**HEAT DISSIPATION FAST**

Dual heat dissipator

Dual heat dissipation make LED headlights work more stably, lifespan longer

**INTELLIGENT TEMPERATURE CONTROLLER**

Enhance 5% lighting efficiency by integrated IC

Integrated IC

**PRODUCT PARAMETER**

Model	H11-H8-H9-H16
Power	28W x 2PCS
Lamp Type	LED
Color Temperature	6000K
Life Time	>30,000 HOURS
Operating Temperature	-40°C A +80°C
Beam Angle	360°
Waterproof	IP67
Material	Aluminum 6063
Socket	H11-H8-H9-H16
IC	Integrated IC

ART. 40802 H7  
ART. 40822 H18



**LED HEADLIGHTS SET SMALL LINE (2 PCS.)**

- LED POWER: 28W (SINGLE)
- HOUSING MATERIAL: AVIATION ALUMINUM 6063
- DUAL FAN SYSTEM HEAT DISSIPATION
- DC 9V-32V
- WATERPROOF: IP67
- 6000LM (LUMEN)
- COLOR TEMPERATURE: 6000K
- LIFETIME: >30.000 HOURS
- OPERATING TEMPERATURE: DA -40°C A +80°C
- BEAM ANGLE: 360°

- LED POWER: 28W (SINGLE)
- COMPONENTE LED CHIP DI ELEVATA EFFICIENZA E QUALITÀ, STUDIATO SPECIFICAMENTE PER KIT A LED
- PRODOTTO IN ALLUMINIO 6063
- DOPPIO DISSIPATORE DEL CALORE CON VENTOLA
- DC 9V-32V
- WATERPROOF: IP67
- 6000LM (LUMEN)
- TEMPERATURA COLORE: 6000K
- LIFETIME: >30.000 ORE
- TEMPERATURA OPERATIVA: DA -40°C A +80°C
- ANGOLO FASCIO D'ILLUMINAZIONE REGOLABILE A 360°

ART. 40801 H4  
ART. 40823 H19



**LED HEADLIGHTS SET SMALL LINE (2 PCS.)**

- LED POWER: 28W/28W (HIGH/LOW)
- HOUSING MATERIAL: AVIATION ALUMINUM 6063
- DUAL FAN SYSTEM HEAT DISSIPATION
- DC 9V-32V
- WATERPROOF: IP67
- 6000LM (LUMEN)
- COLOR TEMPERATURE: 6000K
- LIFETIME: >30.000 HOURS
- OPERATING TEMPERATURE: DA -40°C A +80°C
- BEAM ANGLE: 360°

- LED POWER: 28W/28W (HIGH/LOW)
- COMPONENTE LED CHIP DI ELEVATA EFFICIENZA E QUALITÀ, STUDIATO SPECIFICAMENTE PER KIT A LED
- PRODOTTO IN ALLUMINIO 6063
- DOPPIO DISSIPATORE DEL CALORE CON VENTOLA
- DC 9V-32V
- WATERPROOF: IP67
- 6000LM (LUMEN)
- TEMPERATURA COLORE: 6000K
- LIFETIME: >30.000 ORE
- TEMPERATURA OPERATIVA: DA -40°C A +80°C
- ANGOLO FASCIO D'ILLUMINAZIONE REGOLABILE A 360°

ART. 40803



H11-H8-H9-H16

**LED HEADLIGHTS SET SMALL LINE (2 PCS.)**

- LED POWER: 28W (SINGLE)
- HOUSING MATERIAL: AVIATION ALUMINUM 6063
- DUAL FAN SYSTEM HEAT DISSIPATION
- DC 9V-32V
- WATERPROOF: IP67
- 6000LM (LUMEN)
- COLOR TEMPERATURE: 6000K
- LIFETIME: >30.000 HOURS
- OPERATING TEMPERATURE: DA -40°C A +80°C
- BEAM ANGLE: 360°

- LED POWER: 28W (SINGLE)
- COMPONENTE LED CHIP DI ELEVATA EFFICIENZA E QUALITÀ, STUDIATO SPECIFICAMENTE PER KIT A LED
- PRODOTTO IN ALLUMINIO 6063
- DOPPIO DISSIPATORE DEL CALORE CON VENTOLA
- DC 9V-32V
- WATERPROOF: IP67
- 6000LM (LUMEN)
- TEMPERATURA COLORE: 6000K
- LIFETIME: >30.000 ORE
- TEMPERATURA OPERATIVA: DA -40°C A +80°C
- ANGOLO FASCIO D'ILLUMINAZIONE REGOLABILE A 360°



ART. 40804



HB3-9005

### LED HEADLIGHTS SET SMALL LINE (2 PCS.)

- LED POWER: 28W (SINGLE)
- HOUSING MATERIAL: AVIATION ALUMINIUM 6063
- DUAL FAN SYSTEM HEAT DISSIPATION
- DC 9V-32V
- WATERPROOF: IP67
- 6000LM (LUMEN)
- COLOR TEMPERATURE: 6000K
- LIFETIME: >30.000 HOURS
- OPERATING TEMPERATURE: DA -40°C A +80°C
- BEAM ANGLE: 360°

- LED POWER: 28W (SINGLE)
- COMPONENTE LED CHIP DI ELEVATA EFFICIENZA E QUALITÀ, STUDIATO SPECIFICAMENTE PER KIT A LED
- PRODOTTO IN ALLUMINIO 6063
- DOPPIO DISSIPATORE DEL CALORE CON VENTOLA
- DC 9V-32V
- WATERPROOF: IP67
- 6000LM (LUMEN)
- TEMPERATURA COLORE: 6000K
- LIFETIME: >30.000 ORE
- TEMPERATURA OPERATIVA: DA -40°C A +80°C
- ANGOLO FASCIO D'ILLUMINAZIONE REGOLABILE A 360°

ART. 40807



HB4-9006

### LED HEADLIGHTS SET SMALL LINE (2 PCS.)

- LED POWER: 28W (SINGLE)
- HOUSING MATERIAL: AVIATION ALUMINIUM 6063
- DUAL FAN SYSTEM HEAT DISSIPATION
- DC 9V-32V
- WATERPROOF: IP67
- 6000LM (LUMEN)
- COLOR TEMPERATURE: 6000K
- LIFETIME: >30.000 HOURS
- OPERATING TEMPERATURE: DA -40°C A +80°C
- BEAM ANGLE: 360°

- LED POWER: 28W (SINGLE)
- COMPONENTE LED CHIP DI ELEVATA EFFICIENZA E QUALITÀ, STUDIATO SPECIFICAMENTE PER KIT A LED
- PRODOTTO IN ALLUMINIO 6063
- DOPPIO DISSIPATORE DEL CALORE CON VENTOLA
- DC 9V-32V
- WATERPROOF: IP67
- 6000LM (LUMEN)
- TEMPERATURA COLORE: 6000K
- LIFETIME: >30.000 ORE
- TEMPERATURA OPERATIVA: DA -40°C A +80°C
- ANGOLO FASCIO D'ILLUMINAZIONE REGOLABILE A 360°

ART. 40805



HIR2-9012

### LED HEADLIGHTS SET SMALL LINE (2 PCS.)

- LED POWER: 28W (SINGLE)
- HOUSING MATERIAL: AVIATION ALUMINIUM 6063
- DUAL FAN SYSTEM HEAT DISSIPATION
- DC 9V-32V
- WATERPROOF: IP67
- 6000LM (LUMEN)
- COLOR TEMPERATURE: 6000K
- LIFETIME: >30.000 HOURS
- OPERATING TEMPERATURE: DA -40°C A +80°C
- BEAM ANGLE: 360°

- LED POWER: 28W (SINGLE)
- COMPONENTE LED CHIP DI ELEVATA EFFICIENZA E QUALITÀ, STUDIATO SPECIFICAMENTE PER KIT A LED
- PRODOTTO IN ALLUMINIO 6063
- DOPPIO DISSIPATORE DEL CALORE CON VENTOLA
- DC 9V-32V
- WATERPROOF: IP67
- 6000LM (LUMEN)
- TEMPERATURA COLORE: 6000K
- LIFETIME: >30.000 ORE
- TEMPERATURA OPERATIVA: DA -40°C A +80°C
- ANGOLO FASCIO D'ILLUMINAZIONE REGOLABILE A 360°

ART. 40806



H1

### LED HEADLIGHTS SET SMALL LINE (2 PCS.)

- LED POWER: 28W (SINGLE)
- HOUSING MATERIAL: AVIATION ALUMINIUM 6063
- DUAL FAN SYSTEM HEAT DISSIPATION
- DC 9V-32V
- WATERPROOF: IP67
- 6000LM (LUMEN)
- COLOR TEMPERATURE: 6000K
- LIFETIME: >30.000 HOURS
- OPERATING TEMPERATURE: DA -40°C A +80°C
- BEAM ANGLE: 360°

- LED POWER: 28W (SINGLE)
- COMPONENTE LED CHIP DI ELEVATA EFFICIENZA E QUALITÀ, STUDIATO SPECIFICAMENTE PER KIT A LED
- PRODOTTO IN ALLUMINIO 6063
- DOPPIO DISSIPATORE DEL CALORE CON VENTOLA
- DC 9V-32V
- WATERPROOF: IP67
- 6000LM (LUMEN)
- TEMPERATURA COLORE: 6000K
- LIFETIME: >30.000 ORE
- TEMPERATURA OPERATIVA: DA -40°C A +80°C
- ANGOLO FASCIO D'ILLUMINAZIONE REGOLABILE A 360°

ART. 40809



H3

### LED HEADLIGHTS SET SMALL LINE (2 PCS.)

- LED POWER: 28W (SINGLE)
- HOUSING MATERIAL: AVIATION ALUMINIUM 6063
- DUAL FAN SYSTEM HEAT DISSIPATION
- DC 9V-32V
- WATERPROOF: IP67
- 6000LM (LUMEN)
- COLOR TEMPERATURE: 6000K
- LIFETIME: >30.000 HOURS
- OPERATING TEMPERATURE: DA -40°C A +80°C
- BEAM ANGLE: 360°

- LED POWER: 28W (SINGLE)
- COMPONENTE LED CHIP DI ELEVATA EFFICIENZA E QUALITÀ, STUDIATO SPECIFICAMENTE PER KIT A LED
- PRODOTTO IN ALLUMINIO 6063
- DOPPIO DISSIPATORE DEL CALORE CON VENTOLA
- DC 9V-32V
- WATERPROOF: IP67
- 6000LM (LUMEN)
- TEMPERATURA COLORE: 6000K
- LIFETIME: >30.000 ORE
- TEMPERATURA OPERATIVA: DA -40°C A +80°C
- ANGOLO FASCIO D'ILLUMINAZIONE REGOLABILE A 360°

ART. 40821



P13W

### LED HEADLIGHTS SET SMALL LINE (2 PCS.)

- LED POWER: 28W (SINGLE)
- HOUSING MATERIAL: AVIATION ALUMINIUM 6063
- DUAL FAN SYSTEM HEAT DISSIPATION
- DC 9V-32V
- WATERPROOF: IP67
- 6000LM (LUMEN)
- COLOR TEMPERATURE: 6000K
- LIFETIME: >30.000 HOURS
- OPERATING TEMPERATURE: DA -40°C A +80°C
- BEAM ANGLE: 360°

- LED POWER: 28W (SINGLE)
- COMPONENTE LED CHIP DI ELEVATA EFFICIENZA E QUALITÀ, STUDIATO SPECIFICAMENTE PER KIT A LED
- PRODOTTO IN ALLUMINIO 6063
- DOPPIO DISSIPATORE DEL CALORE CON VENTOLA
- DC 9V-32V
- WATERPROOF: IP67
- 6000LM (LUMEN)
- TEMPERATURA COLORE: 6000K
- LIFETIME: >30.000 ORE
- TEMPERATURA OPERATIVA: DA -40°C A +80°C
- ANGOLO FASCIO D'ILLUMINAZIONE REGOLABILE A 360°

ART. 40820



PSX26W

### LED HEADLIGHTS SET SMALL LINE (2 PCS.)

- LED POWER: 28W (SINGLE)
- HOUSING MATERIAL: AVIATION ALUMINIUM 6063
- DUAL FAN SYSTEM HEAT DISSIPATION
- DC 9V-32V
- WATERPROOF: IP67
- 6000LM (LUMEN)
- COLOR TEMPERATURE: 6000K
- LIFETIME: >30.000 HOURS
- OPERATING TEMPERATURE: DA -40°C A +80°C
- BEAM ANGLE: 360°

- LED POWER: 28W (SINGLE)
- COMPONENTE LED CHIP DI ELEVATA EFFICIENZA E QUALITÀ, STUDIATO SPECIFICAMENTE PER KIT A LED
- PRODOTTO IN ALLUMINIO 6063
- DOPPIO DISSIPATORE DEL CALORE CON VENTOLA
- DC 9V-32V
- WATERPROOF: IP67
- 6000LM (LUMEN)
- TEMPERATURA COLORE: 6000K
- LIFETIME: >30.000 ORE
- TEMPERATURA OPERATIVA: DA -40°C A +80°C
- ANGOLO FASCIO D'ILLUMINAZIONE REGOLABILE A 360°

FAN LINE (ENTRY LEVEL)

FAN LINE (ENTRY LEVEL)

ART. 40502



RIDOTTE DIMENSIONI

LED HEADLIGHTS SET (2 PCS.)

- ALL IN ONE COMPACT DESIGN
- LED POWER: 30W (SINGLE)
- IMPORTED HIGH POWER FLIP CHIP
- CAR INSPECTION STANDARD
- COPPER SUBSTRATE
- HEAT-ELECTRIC SEPARATED TECHNOLOGY
- MORE SECURE, MORE EFFICIENT
- HIGH SPEED COOLING FAN SYSTEM
- FORCED COOLING
- DC 8V-48V
- INPUT 1.2A±0.1A
- WATERPROOF: IP68
- 4500LM (LUMEN)
- COLOR TEMPERATURE: 6000K
- LIFETIME: >30.000 HOURS
- OPERATING TEMPERATURE: DA -50°C A +90°C
- STANDARD BEAM PATTERN

ART. 40501



RIDOTTE DIMENSIONI

LED HEADLIGHTS SET (2 PCS.)

- ALL IN ONE COMPACT DESIGN
- LED POWER: 30W X 2
- IMPORTED HIGH POWER FLIP CHIP
- CAR INSPECTION STANDARD
- COPPER SUBSTRATE
- HEAT-ELECTRIC SEPARATED TECHNOLOGY
- MORE SECURE, MORE EFFICIENT
- HIGH SPEED COOLING FAN SYSTEM
- FORCED COOLING
- DC 8V-48V
- INPUT 1.2A±0.1A
- WATERPROOF: IP68
- 4500LM (LUMEN)
- COLOR TEMPERATURE: 6000K
- LIFETIME: >30.000 HOURS
- OPERATING TEMPERATURE: DA -50°C A +90°C
- STANDARD BEAM PATTERN

ART. 40503



RIDOTTE DIMENSIONI

LED HEADLIGHTS SET (2 PCS.)

- ALL IN ONE COMPACT DESIGN
- LED POWER: 30W (SINGLE)
- IMPORTED HIGH POWER FLIP CHIP
- CAR INSPECTION STANDARD
- COPPER SUBSTRATE
- HEAT-ELECTRIC SEPARATED TECHNOLOGY
- MORE SECURE, MORE EFFICIENT
- HIGH SPEED COOLING FAN SYSTEM
- FORCED COOLING
- DC 8V-48V
- INPUT 1.2A±0.1A
- WATERPROOF: IP68
- 4500LM (LUMEN)
- COLOR TEMPERATURE: 6000K
- LIFETIME: >30.000 HOURS
- OPERATING TEMPERATURE: DA -50°C A +90°C
- STANDARD BEAM PATTERN

ART. 40506



RIDOTTE DIMENSIONI

LED HEADLIGHTS SET (2 PCS.)

- ALL IN ONE COMPACT DESIGN
- LED POWER: 30W (SINGLE)
- IMPORTED HIGH POWER FLIP CHIP
- CAR INSPECTION STANDARD
- COPPER SUBSTRATE
- HEAT-ELECTRIC SEPARATED TECHNOLOGY
- MORE SECURE, MORE EFFICIENT
- HIGH SPEED COOLING FAN SYSTEM
- FORCED COOLING
- DC 8V-48V
- INPUT 1.2A±0.1A
- WATERPROOF: IP68
- 4500LM (LUMEN)
- COLOR TEMPERATURE: 6000K
- LIFETIME: >30.000 HOURS
- OPERATING TEMPERATURE: DA -50°C A +90°C
- STANDARD BEAM PATTERN

ART. 40505



RIDOTTE DIMENSIONI

LED HEADLIGHTS SET (2 PCS.)

- ALL IN ONE COMPACT DESIGN
- LED POWER: 30W (SINGLE)
- IMPORTED HIGH POWER FLIP CHIP
- CAR INSPECTION STANDARD
- COPPER SUBSTRATE
- HEAT-ELECTRIC SEPARATED TECHNOLOGY
- MORE SECURE, MORE EFFICIENT
- HIGH SPEED COOLING FAN SYSTEM
- FORCED COOLING
- DC 8V-48V
- INPUT 1.2A±0.1A
- WATERPROOF: IP68
- 4500LM (LUMEN)
- COLOR TEMPERATURE: 6000K
- LIFETIME: >30.000 HOURS
- OPERATING TEMPERATURE: DA -50°C A +90°C
- STANDARD BEAM PATTERN

ART. 40509



RIDOTTE DIMENSIONI

LED HEADLIGHTS SET (2 PCS.)

- ALL IN ONE COMPACT DESIGN
- LED POWER: 30W (SINGLE)
- IMPORTED HIGH POWER FLIP CHIP
- CAR INSPECTION STANDARD
- COPPER SUBSTRATE
- HEAT-ELECTRIC SEPARATED TECHNOLOGY
- MORE SECURE, MORE EFFICIENT
- HIGH SPEED COOLING FAN SYSTEM
- FORCED COOLING
- DC 8V-48V
- INPUT 1.2A±0.1A
- WATERPROOF: IP68
- 4500LM (LUMEN)
- COLOR TEMPERATURE: 6000K
- LIFETIME: >30.000 HOURS
- OPERATING TEMPERATURE: DA -50°C A +90°C
- STANDARD BEAM PATTERN

ART. 40504



RIDOTTE DIMENSIONI

LED HEADLIGHTS SET (2 PCS.)

- ALL IN ONE COMPACT DESIGN
- LED POWER: 30W (SINGLE)
- IMPORTED HIGH POWER FLIP CHIP
- CAR INSPECTION STANDARD
- COPPER SUBSTRATE
- HEAT-ELECTRIC SEPARATED TECHNOLOGY
- MORE SECURE, MORE EFFICIENT
- HIGH SPEED COOLING FAN SYSTEM
- FORCED COOLING
- DC 8V-48V
- INPUT 1.2A±0.1A
- WATERPROOF: IP68
- 4500LM (LUMEN)
- COLOR TEMPERATURE: 6000K
- LIFETIME: >30.000 HOURS
- OPERATING TEMPERATURE: DA -50°C A +90°C
- STANDARD BEAM PATTERN

ART. 40507



RIDOTTE DIMENSIONI

LED HEADLIGHTS SET (2 PCS.)

- ALL IN ONE COMPACT DESIGN
- LED POWER: 30W (SINGLE)
- IMPORTED HIGH POWER FLIP CHIP
- CAR INSPECTION STANDARD
- COPPER SUBSTRATE
- HEAT-ELECTRIC SEPARATED TECHNOLOGY
- MORE SECURE, MORE EFFICIENT
- HIGH SPEED COOLING FAN SYSTEM
- FORCED COOLING
- DC 8V-48V
- INPUT 1.2A±0.1A
- WATERPROOF: IP68
- 4500LM (LUMEN)
- COLOR TEMPERATURE: 6000K
- LIFETIME: >30.000 HOURS
- OPERATING TEMPERATURE: DA -50°C A +90°C
- STANDARD BEAM PATTERN



GOLD LINE LENTICOLARE (LENS)

GOLD LINE LENTICOLARE (LENS)

GOLD LINE LENTICOLARE



ALUMINUM LIGHT BODY

48 WATT CAN BUS ULTIMA GENERAZIONE

10.000 LUMEN PER LAMPADA

IL KIT A LED DELLA SERIE GOLD LENTICOLARE È STUDIATO SPECIFICAMENTE PER DARE LA MASSIMA ILLUMINAZIONE SUI FARI LENTICOLARI, PERTANTO È SCONSIGLIATA L'INSTALLAZIONE SU FARI SPROVVISTI DILENTE.



ART. 40902 H7  
ART. 40922 H18

LENTICOLARE  
10.000 LUMEN

LED HEADLIGHTS SET LENTICOLARE (LENS) (2 PCS.)

- LED POWER: 48W (SINGLE)
- COMPONENTE LED CHIP DI ELEVATA EFFICIENZA E QUALITÀ, STUDIATO SPECIFICAMENTE PER KIT A LED
- PRODOTTO IN ALLUMINIO 6063
- DOPPIO DISSIPATORE DEL CALORE CON VENTOLA
- DC 9V-32V
- WATERPROOF: IP67
- 6000LM (LUMEN)
- TEMPERATURA COLORE: 6000K
- LIFETIME: >30.000 ORE
- TEMPERATURA OPERATIVA: DA -50°C A +90°C
- ANGOLO FASCIO D'ILLUMINAZIONE REGOLABILE A 180°

ART. 40903 H11

LENTICOLARE  
10.000 LUMEN

LED HEADLIGHTS SET LENTICOLARE (LENS) (2 PCS.)

- LED POWER: 48W (SINGLE)
- COMPONENTE LED CHIP DI ELEVATA EFFICIENZA E QUALITÀ, STUDIATO SPECIFICAMENTE PER KIT A LED
- PRODOTTO IN ALLUMINIO 6063
- DOPPIO DISSIPATORE DEL CALORE CON VENTOLA
- DC 9V-32V
- WATERPROOF: IP67
- 6000LM (LUMEN)
- TEMPERATURA COLORE: 6000K
- LIFETIME: >30.000 ORE
- TEMPERATURA OPERATIVA: DA -50°C A +90°C
- ANGOLO FASCIO D'ILLUMINAZIONE REGOLABILE A 180°

ART. 40904

LENTICOLARE  
10.000 LUMEN

HB3-9005

LED HEADLIGHTS SET LENTICOLARE (LENS) (2 PCS.)

- LED POWER: 48W (SINGLE)
- COMPONENTE LED CHIP DI ELEVATA EFFICIENZA E QUALITÀ, STUDIATO SPECIFICAMENTE PER KIT A LED
- PRODOTTO IN ALLUMINIO 6063
- DOPPIO DISSIPATORE DEL CALORE CON VENTOLA
- DC 9V-32V
- WATERPROOF: IP67
- 6000LM (LUMEN)
- TEMPERATURA COLORE: 6000K
- LIFETIME: >30.000 ORE
- TEMPERATURA OPERATIVA: DA -50°C A +90°C
- ANGOLO FASCIO D'ILLUMINAZIONE REGOLABILE A 180°

ART. 40905

LENTICOLARE  
10.000 LUMEN

HIR2-9012

LED HEADLIGHTS SET LENTICOLARE (LENS) (2 PCS.)

- LED POWER: 48W (SINGLE)
- COMPONENTE LED CHIP DI ELEVATA EFFICIENZA E QUALITÀ, STUDIATO SPECIFICAMENTE PER KIT A LED
- PRODOTTO IN ALLUMINIO 6063
- DOPPIO DISSIPATORE DEL CALORE CON VENTOLA
- DC 9V-32V
- WATERPROOF: IP67
- 6000LM (LUMEN)
- TEMPERATURA COLORE: 6000K
- LIFETIME: >30.000 ORE
- TEMPERATURA OPERATIVA: DA -50°C A +90°C
- ANGOLO FASCIO D'ILLUMINAZIONE REGOLABILE A 180°

ART. 40917\* SPECIFICO HB3-9005 MOTORIZZATO (EVOQUE, ETC.)

LENTICOLARE MOTORIZZATO  
6.000 LUMEN

LED HEADLIGHTS SET LENTICOLARE (LENS) (2 PCS.)

- LED POWER: 48W (SINGLE)
- COMPONENTE LED CHIP DI ELEVATA EFFICIENZA E QUALITÀ, STUDIATO SPECIFICAMENTE PER KIT A LED
- PRODOTTO IN ALLUMINIO 6063
- DOPPIO DISSIPATORE DEL CALORE CON VENTOLA
- DC 9V-32V
- WATERPROOF: IP67
- 6000LM (LUMEN)
- TEMPERATURA COLORE: 6000K
- LIFETIME: >30.000 ORE
- TEMPERATURA OPERATIVA: DA -50°C A +90°C
- ANGOLO FASCIO D'ILLUMINAZIONE REGOLABILE A 180°

\*VERSIONE MOTORIZZATA SI INTENDE QUANDO CON UN'UNICA LAMPADINA SI AGISCE SIA SU ANABBAGLIANTI CHE ABBAGLIANTI

ART. 40918\* SPECIFICO HIR2-9012 MOTORIZZATO (TOYOTA, ETC.)

LENTICOLARE MOTORIZZATO  
6.000 LUMEN

LED HEADLIGHTS SET LENTICOLARE (LENS) (2 PCS.)

- LED POWER: 48W (SINGLE)
- COMPONENTE LED CHIP DI ELEVATA EFFICIENZA E QUALITÀ, STUDIATO SPECIFICAMENTE PER KIT A LED
- PRODOTTO IN ALLUMINIO 6063
- DOPPIO DISSIPATORE DEL CALORE CON VENTOLA
- DC 9V-32V
- WATERPROOF: IP67
- 6000LM (LUMEN)
- TEMPERATURA COLORE: 6000K
- LIFETIME: >30.000 ORE
- TEMPERATURA OPERATIVA: DA -50°C A +90°C
- ANGOLO FASCIO D'ILLUMINAZIONE REGOLABILE A 180°

\*VERSIONE MOTORIZZATA SI INTENDE QUANDO CON UN'UNICA LAMPADINA SI AGISCE SIA SU ANABBAGLIANTI CHE ABBAGLIANTI

ART. 40906

LENTICOLARE  
6.000 LUMEN

H1

LED HEADLIGHTS SET LENTICOLARE (LENS) (2 PCS.)

- LED POWER: 48W (SINGLE)
- COMPONENTE LED CHIP DI ELEVATA EFFICIENZA E QUALITÀ, STUDIATO SPECIFICAMENTE PER KIT A LED
- PRODOTTO IN ALLUMINIO 6063
- DOPPIO DISSIPATORE DEL CALORE CON VENTOLA
- DC 9V-32V
- WATERPROOF: IP67
- 6000LM (LUMEN)
- TEMPERATURA COLORE: 6000K
- LIFETIME: >30.000 ORE
- TEMPERATURA OPERATIVA: DA -50°C A +90°C
- ANGOLO FASCIO D'ILLUMINAZIONE REGOLABILE A 180°



## KIT A LED "TRUCK LINE" SPECIFICO TRUCK 24 VOLT CAN BUS



**PARABOLA &  
LENTICOLARE**

• IVECO STRALIS EURO 4/5/6 NO PROBLEM CON FILTRO 40259

**8000 LUMEN**  
PER LAMPADA

ART. 40752 - H7  
ART. 40751 - H4  
ART. 40753 - H11



**HS GROUP SEMPRE ALL'AVANGUARDIA AL VOSTRO FIANCO**

ART. 40252 (12 VOLT)

ART. 40259 (24 VOLT)

H7



DIGITAL LED WARNING CANCELLER (H7)  
FILTRO RESISTENZA PER KIT LED H7

ART. 40251

H1-H3



DIGITAL LED WARNING CANCELLER (H1 H3)  
FILTRO RESISTENZA PER KIT LED H1 H3

• CANBUS NO ERROR 12V 30W

ART. 40255

H4



DIGITAL LED WARNING CANCELLER (H4)  
FILTRO RESISTENZA PER KIT LED H4

• BI-LED  
• CANBUS NO ERROR 12V 40/40W

ART. 40256

H7



NO ERROR WARNING CANCELLER (H7)  
RESISTENZA PER LAMPADA LED H7

• 50W  
• 6 OHM

ART. 40253

H8-H9-H11

ART. 40254

HB3-9005-HB4-9006-H10 - HIR2



DIGITAL LED WARNING CANCELLER (H8 H9 H11 HB3 9005  
HB4 9006 H10 HIR2)  
FILTRO RESISTENZA PER KIT LED (H8 H9 H11 HB3 9005  
HB4 9006 H10 HIR2)

• CANBUS NO ERROR 12V 40W

ART. 40257

H8-H9-H11



NO ERROR WARNING CANCELLER (H8 H9 H11)  
RESISTENZA PER LAMPADA LED H8 H9 H11

• 50W  
• 6 OHM

ART. 40260

H15



DIGITAL LED WARNING CANCELLER (H15)  
FILTRO RESISTENZA PER KIT LED (H15)

• CANBUS NO ERROR 12V 40W

ART. 40258

HB3-9005  
HB4-9006  
H10 - HIR2



NO ERROR WARNING CANCELLER (HB3 9005 HB4 9006 H10  
HIR2)  
RESISTENZA PER LAMPADA LED HB3 9005 HB4 9006 H10  
HIR2

• 50W • 6 OHM



## DECODER H7

IL DECODER 41262 RISOLVE AL 100% TUTTE LE PROBLEMATICHE CAN BUS, SULLE AUTO DI NUOVA GENERAZIONE (SPIA ACCESA, TREMOLIO, LAMPEGGI, ECC.)

**IL KIT È COMPOSTO DA 2 DECODER E 2 RESISTENZE.  
FACILE INSTALLAZIONE PLUG AND PLAY.**

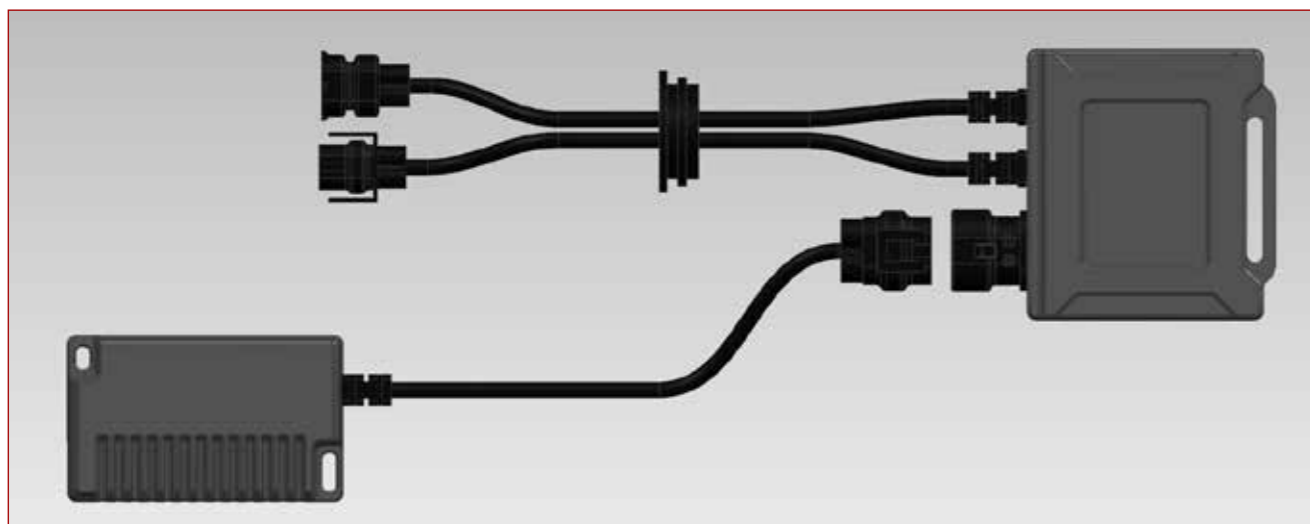

**ART. 41262  
DECODER H7**



## DECODER H4

IL DECODER 41261 RISOLVE AL 100% TUTTE LE PROBLEMATICHE CAN BUS, SULLE AUTO DI NUOVA GENERAZIONE (SPIA ACCESA, TREMOLIO, LAMPEGGI, ECC.)

**IL KIT È COMPOSTO DA 2 DECODER E 2 RESISTENZE.  
FACILE INSTALLAZIONE PLUG AND PLAY.**

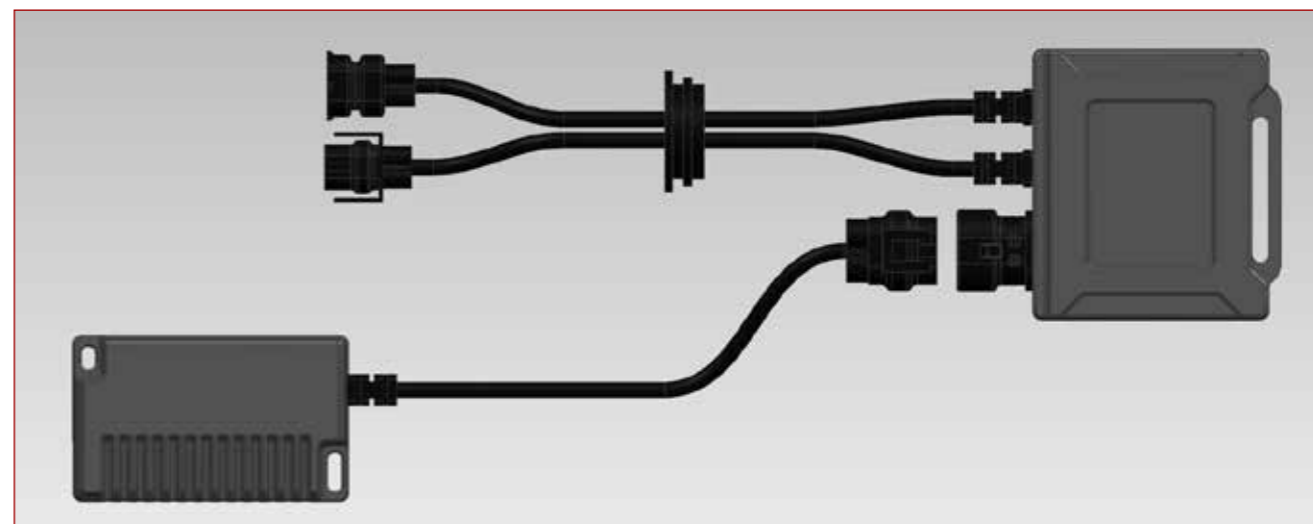

**ART. 41261  
DECODER H4**



ART. 40215

**KIT LED ADAPTER (H7)  
PORTALAMPADA PER KIT LED H7**

- ALFA ROMEO MITO
- AUDI A6
- FORD KUGA
- RENAULT MEGANE 4
- VW SAGITAR,  
PASSAT 3C, TOURAN
- FORO 23 mm



ART. 40210

**KIT LED ADAPTER (H7)  
PORTALAMPADA PER KIT LED H7**

- FIAT NUOVA 500, 500x, 500L
- FORD FOCUS
- OPEL CORSA D (con piccola modifica)
- LAND ROVER DISCOVERY

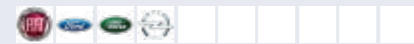

ART. 40214

**KIT LED ADAPTER (H7)  
PORTALAMPADA PER KIT LED H7**

- FORD MONDEO, FOCUS, FIESTA
- ANABBAGLIANTE

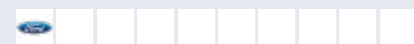

ART. 40208

**KIT LED ADAPTER (H1)  
PORTALAMPADA PER KIT LED H1**

- FORD FOCUS, MONDEO, FIESTA
- ABBAGLIANTE

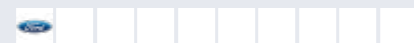

ART. 40209

**KIT LED ADAPTER (H7)  
PORTALAMPADA PER KIT LED H7**

- FORD FOCUS, MONDEO, FIESTA
- ANABBAGLIANTE
- FORO 24 mm

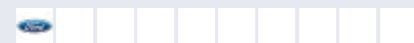

ART. 40207

**KIT LED ADAPTER (H7)  
PORTALAMPADA PER KIT LED H7**

- CITROEN C5, DS5,  
DS6, C3 PICASSO
- FORD MONDEO
- PEUGEOT 508, 2008,  
3008
- FORO 23 mm

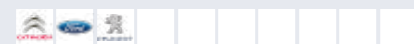

ART. 40227

**KIT LED ADAPTER (H7)  
PORTALAMPADA PER KIT LED H7**

- HYUNDAI TUCSON 2018, VELOSTER COUPE,  
SONATA, SANTA FE
- KIA K3, K4, K5, GREA, SORENTO, SPORTAGE, GRIEG
- FORO 23 mm



ART. 40203

**KIT LED ADAPTER (H7)  
PORTALAMPADA PER KIT LED H7**

- AUDI
- BMW
- MERCEDES CLASSE B, C, GLA, GL
- FORO 22 mm

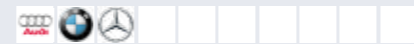

ART. 40204

**KIT LED ADAPTER (H7)  
PORTALAMPADA PER KIT LED H7**

- UNIVERSALE
- AUDI A3, A4L, A6L
- BMW SERIE 5, X5
- BUICK REGAL,  
EXCELLE, LACROSS
- MERCEDES  
CLASSE E, ML
- NISSAN QASHQAI
- OPEL ASTRA
- RENAULT MASTER
- VW NEW BORA



ART. 40205

**KIT LED ADAPTER (H7)  
PORTALAMPADA PER KIT LED H7**

- MERCEDES SPRINTER
- SEAT ALHAMBRA 2012
- VW GOLF VI, VII, SCIROCCO
- FORO 22 mm

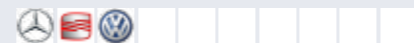

ART. 40213

**KIT LED ADAPTER (H7)  
PORTALAMPADA PER KIT LED H7**

- MG GS
- SKODA OCTAVIA
- VW POLO
- FORO 24 mm

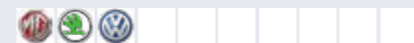

ART. 40211

**KIT LED ADAPTER (H7)**

**SU QUESTE AUTO SI SCONSIGLIA L'UTILIZZO DI QUESTO ADATTATORE,  
MEGLIO UTILIZZARE IL KIT A LED SPECIFICO ART. 40617 A PAGINA 4**

- MERCEDES SPRINTER
- SEAT ALHAMBRA 2012
- VW GOLF VI, VII, SHARAN, TOURAN, SCIROCCO,  
POLO 2013
- AUTO ALIMENTAZIONE CON SPINA
- FORO 23 mm

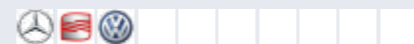

ART. 40206

**KIT LED ADAPTER (H7)  
PORTALAMPADA PER KIT LED H7**

- VW JETTA, GOLF IV, GOLF V, TOURAN, TIGUAN



ART. 40216

**KIT LED ADAPTER (H7)  
PORTALAMPADA PER KIT LED H7**

- HONDA CRV
- MAZDA
- OPEL ASTRA G,  
ZAFIRA
- FORO 28 mm



ART. 40217

**KIT LED ADAPTER (H7)  
PORTALAMPADA PER KIT LED H7**

- HYUNDAI NUOVO TUCSON, LAVITA, ELANTRA,  
MISTRA
- KIA



ART. 40218

**KIT LED ADAPTER (H1)  
PORTALAMPADA PER KIT LED H1**

- DONGFENG FENGXING
- HONDA ODYSSEY, GEELY, MOTO GL EAGLET,  
SOUEAST, V3, V5, V6
- FORO 19 mm



ART. 40225

**KIT LED ADAPTER (H7)  
PORTALAMPADA PER KIT LED H7**

- VW TOURAN
- FORD FIESTA
- SKODA OCTAVIA
- OPEL
- SAAB



ART. 40212

**KIT LED ADAPTER (H7)  
PORTALAMPADA PER KIT LED H7**

- HYUNDAI I30 SW 2012
- KIA K5



ART. 40219

**KIT LED ADAPTER (H7)  
PORTALAMPADA PER KIT LED H7**

- HONDA CRV
- MAZDA
- OPEL
- FORO 24 mm



ART. 40220

**OLD CAR BULB ADAPTER  
ADATTATORE DA ATTACCO H4 HS1  
A H5 R2 G40 PORTALAMPADA KIT  
XENON E LED PER AUTO D'EPOCA**

- KIT RIDUTTORE ADATTATORE CONVERTITORE DA  
ATTACCO H4 HS1 P43T A H5 R2 G40 P45T
- CON QUESTI ADATTATORI POTETE INSTALLARE  
KIT XENON E LED H4 NELLE VECCHIE LAMPADE  
ASIMMETRICHE
- ADATTO PER AUTO D'EPOCA FIAT 500 F L R FIAT  
126 FIAT 112 FIAT 600 MINI E SCOOTER ECT.
- KIT COMPRENDE 2 ADATTATORI METALLICI  
PER LAMPADE ASIMMETRICHE + 2 BLOCCHI DI  
METALLO



ART. 40224

**KIT LED ADAPTER (H7)  
PORTALAMPADA PER KIT LED H7**

- KIA RIO, CARENS
- HYUNDAI ELANTRA, AZERA, VELOSTAR, MISTRA,  
H350, SONATA
- FORO 22mm

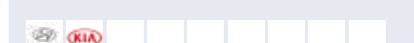

ART. 40223

**KIT FERMAGLI IN FERRO  
DI RITENUTA LAMPADE PER FANALE  
(13 PEZZI)**

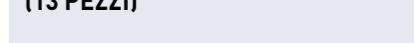

ART. 40226

**KIT LED ADAPTER (H7)  
PORTALAMPADA PER KIT LED H7**

- FORD FIESTA 2019

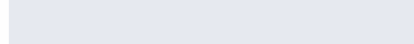

ART. 40201

**REAR COVER  
RUBBER  
TAPPO FORATO**

- DIAMETRO  
100 mm



ART. 40221

**REAR COVER RUBBER  
TAPPO CUFFIA**

- DIAMETRO  
55 mm



ART. 40222

**REAR COVER RUBBER  
TAPPO CUFFIA**

- DIAMETRO  
73 mm





**FULL CAN BUS**  
(VENTOLA INTERNA  
DI RAFFREDDAMENTO)

**60 LED**  
**1200 LM**



ART. 41060

**SINGOLO FILAMENTO**  
**60 LED - 1200 LM**

**FULL CAN BUS**  
(VENTOLA INTERNA  
DI RAFFREDDAMENTO)



- 60\*3623SMD
- LED SAMSUNG
- CAN BUS
- 680±20MA
- NO-POLARITY
- CONSTANT CURRENT IC
- SURGE VOLTAGE 18V
- 12V-16.5V
- 1156
- LAMPADA DI POSIZIONE A LED
- BA15S - 1156 - P21W
- SINGOLO FILAMENTO
- CAN BUS NO ERROR
- 12 VOLT
- 60 LED ALTA LUMINOSITA'
- 1200LM
- WHITE 5500K

ART. 41061

**DOPPIO FILAMENTO**  
**60 LED - 1200 LM**

**FULL CAN BUS**  
(VENTOLA INTERNA  
DI RAFFREDDAMENTO)



- 60\*3623SMD
- LED SAMSUNG
- CAN BUS
- H: 680±20MA - L: 80±10MA
- REVERSE POLARITY PROTECTION
- CONSTANT CURRENT IC
- SURGE VOLTAGE 18V
- 12V-16.5V
- 1157
- LAMPADA DI POSIZIONE A LED
- BAY15D - 1157 - P21W/5W
- DOPPIO FILAMENTO
- CAN BUS NO ERROR
- 12 VOLT
- 60 LED ALTA LUMINOSITA'
- 1200LM
- WHITE 5500K

ART. 41051

**DOPPIO FILAMENTO**  
**60 LED - 1200 LM**

**FULL CAN BUS**  
(VENTOLA INTERNA  
DI RAFFREDDAMENTO)



- 60\*3623SMD
- LED SAMSUNG
- CAN BUS
- H: 680±20MA - L: 80±10MA
- REVERSE POLARITY PROTECTION
- CONSTANT CURRENT IC
- SURGE VOLTAGE 18V
- 12V-16.5V
- 7443
- LAMPADA DI POSIZIONE A LED
- T20 - 7443 - W21/5W
- DOPPIO FILAMENTO
- CAN BUS NO ERROR
- 12 VOLT
- 60 LED ALTA LUMINOSITA'
- 1200LM - WHITE 5500K

ART. 41050

**SINGOLO FILAMENTO**  
**60 LED - 1200 LM**

**FULL CAN BUS**  
(VENTOLA INTERNA  
DI RAFFREDDAMENTO)



- 60\*3623SMD
- LED SAMSUNG
- CANBUS
- 680± 20MA
- NO-POLARITY
- CONSTANT CURRENT IC
- SURGE VOLTAGE 18V
- 12V-16.5V
- 7440
- LAMPADA DI POSIZIONE A LED
- T20 - 7440 - W21W
- SINGOLO FILAMENTO
- CAN BUS NO ERROR
- 12 VOLT
- 60 LED ALTA LUMINOSITA'
- 1200LM
- WHITE 5500K

ART. 41062

**60 LED - 1200 LM**  
**LUCE FRECCIE**  
**COLOR ARANCIONE**

**FULL CAN BUS**  
(VENTOLA INTERNA  
DI RAFFREDDAMENTO)



- 60\*3623SMD
- LED SAMSUNG
- CANBUS
- 680± 20MA
- NO-POLARITY
- CONSTANT CURRENT IC
- SURGE VOLTAGE 18V
- 12V-16.5V
- 7440
- LAMPADA FRECCIE A LED
- PY21W - S25 - BAU15
- 12V - 21W
- SINGOLO FILAMENTO
- CAN BUS NO ERROR
- 12 VOLT
- 60 LED ALTA LUMINOSITA'
- 1200LM
- LUCE ARANCIONE FRECCIE

**NON NECESSITA DI RESISTENZA.**  
**IL TEMPO DI INTERMITTENZA RIMANE INVARIATO.**



**ART. 41001**



- 12\*3623SMD
  - LED SAMSUNG
  - CANBUS
  - 190±10MA 12V
  - NON-POLARITY
  - CONSTANT CURRENT IC
  - SURGE VOLTAGE 32V
  - 9-30V
  - 500 LM
  - WHITE 5500K
- LAMPADA DI POSIZIONE A LED
  - T10 W5W
  - TUTTO VETRO
  - CAN BUS NO ERROR
  - 12/24VOLT
  - LUCE BIANCA FREDDA 5500K
  - 12 LED ALTA LUMINOSITA'

**ART. 41003**

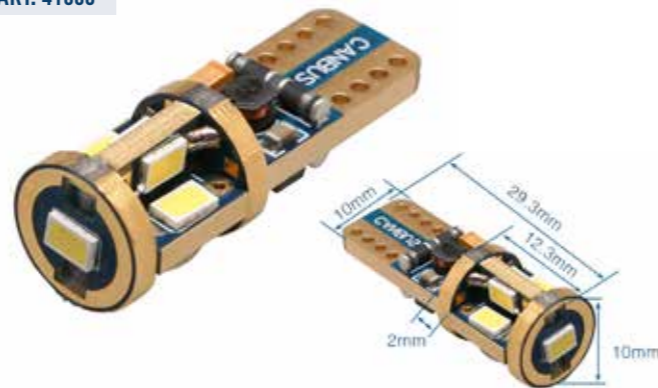

- 9\*3623SMD
  - LED SAMSUNG
  - SUPER CANBUS
  - 250±10MA
  - NON-POLARITY
  - COSTANT CURRENT IC
  - SURGE VOLTAGE 18V
  - 12-14.5V
  - 400 LM
  - WHITE 5500K
- LAMPADA DI POSIZIONE A LED
  - T10 W5W
  - TUTTO VETRO
  - CAN BUS NO ERROR
  - 12 VOLT
  - LUCE BIANCA FREDDA 5500K
  - 9 LED ALTA LUMINOSITA'

**ART. 41002**



- 15 LED SMD 4014
  - CANBUS
  - 250±10MA
  - NON-POLARITY
  - CONSTANT CURRENT IC
  - SURGE VOLTAGE 18V
  - 12V-14.5V
  - 350 LM
  - WHITE 5500K
- LAMPADA DI POSIZIONE A LED
  - T10 W5W
  - TUTTO VETRO
  - CAN BUS NO ERROR
  - 12 VOLT
  - LUCE BIANCA FREDDA 5500K
  - 15 LED ALTA LUMINOSITA'

**ART. 41004**

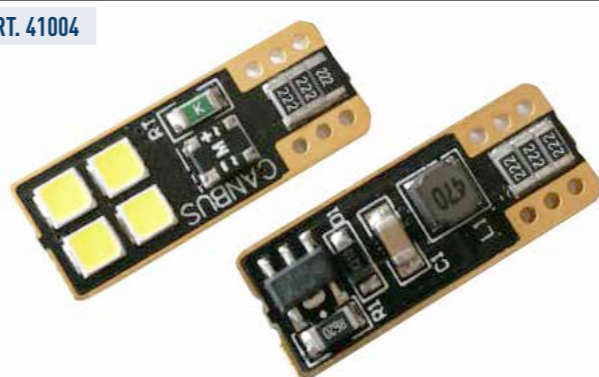

- 4\*3623SMD
  - LED SAMSUNG
  - SUPER CANBUS
  - 250±10MA
  - NON-POLARITY
  - COSTANT CURRENT IC
  - SURGE VOLTAGE 18V
  - 12V-14.5V
  - 300 LM
  - WHITE 5500K
- LAMPADA DI POSIZIONE A LED
  - T10 W5W
  - TUTTO VETRO
  - CAN BUS NO ERROR
  - 12 VOLT
  - LUCE BIANCA FREDDA 5500K
  - 4 LED ALTA LUMINOSITA'

**ART. 41005**

**LUCE 360°**



- 4\*3623SMD
  - LED SAMSUNG
  - SUPER CANBUS
  - 250±10MA
  - NON-POLARITY
  - COSTANT CURRENT IC
  - SURGE VOLTAGE 18V
  - 12V-14.5V
  - 400 LM
  - WHITE 5500K
- LAMPADA DI POSIZIONE A LED
  - T10 W5W
  - TUTTO VETRO
  - CAN BUS NO ERROR
  - 12 VOLT - 5W
  - LUCE BIANCA FREDDA 5500K
  - 4 LED ALTA LUMINOSITA'

**ART. 41066**



**PIEDI DRITTI T4W**

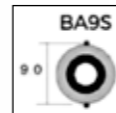

- 15 LED SMD 4014
  - SUPER CANBUS
  - NON-POLARITY
  - CONSTANT CURRENT IC
  - INDUCTANCE CIRCUIT
  - SURGE VOLTAGE 18V
  - 12-14.5V
  - 300LM
  - WHITE 5500K
- LAMPADA DI POSIZIONE A LED
  - BA9S
  - CAN BUS NO ERROR
  - 12 VOLT
  - LUCE BIANCA FREDDA 5500K
  - 15 LED ALTA LUMINOSITA'

**ART. 41065**



**PIEDI STORTI H6W**



- 15 LED SMD 4014
  - SUPER CANBUS
  - NON-POLARITY
  - CONSTANT CURRENT IC
  - INDUCTANCE CIRCUIT
  - SURGE VOLTAGE 18V
  - 12-14.5V
  - 300LM
  - WHITE 5500K
- LAMPADA DI POSIZIONE A LED
  - BAX9S
  - CAN BUS NO ERROR
  - 12 VOLT
  - LUCE BIANCA FREDDA 5500K
  - 15 LED ALTA LUMINOSITA'

**ART. 41030**

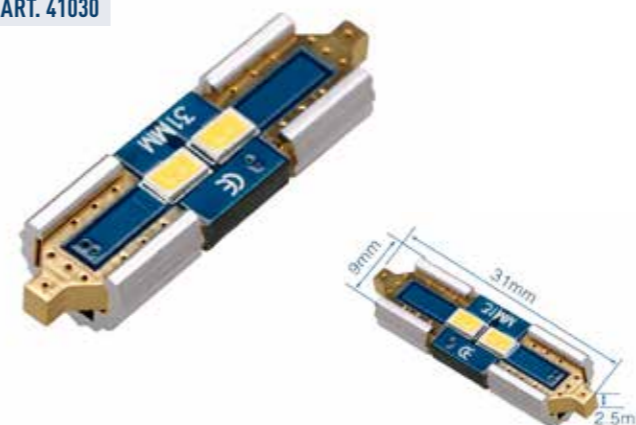

- 2\*3623SMD
  - LED SAMSUNG
  - CANBUS
  - 130±10MA
  - NON-POLARITY
  - 12V-14.5V
  - 31MM
  - 80LM
  - WHITE 5500K
- LAMPADA DI POSIZIONE A LED
  - SILURO 31MM
  - CAN BUS NO ERROR
  - 12 VOLT
  - LUCE BIANCA FREDDA 5500K
  - 2 LED ALTA LUMINOSITA'
  - T11

**ART. 41031**

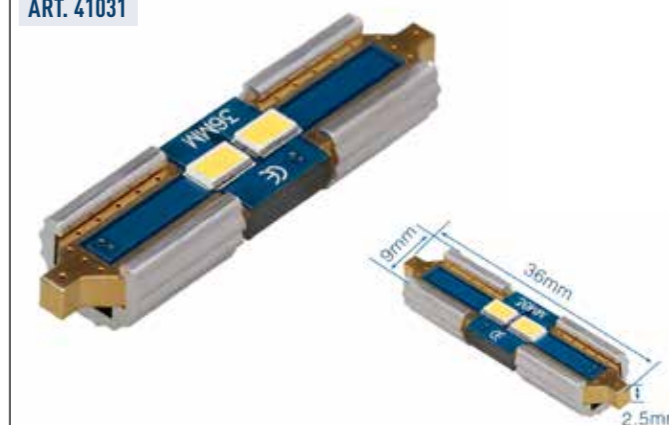

- 2\*3623SMD
  - LED SAMSUNG
  - CANBUS
  - 160±10MA
  - NON-POLARITY
  - 12V-14.5V
  - 36MM
  - 100LM
  - WHITE 5500K
- LAMPADA DI POSIZIONE A LED
  - SILURO 36MM
  - CAN BUS NO ERROR
  - 12 VOLT
  - LUCE BIANCA FREDDA 5500K
  - 2 LED ALTA LUMINOSITA'
  - T11

**ART. 41032**

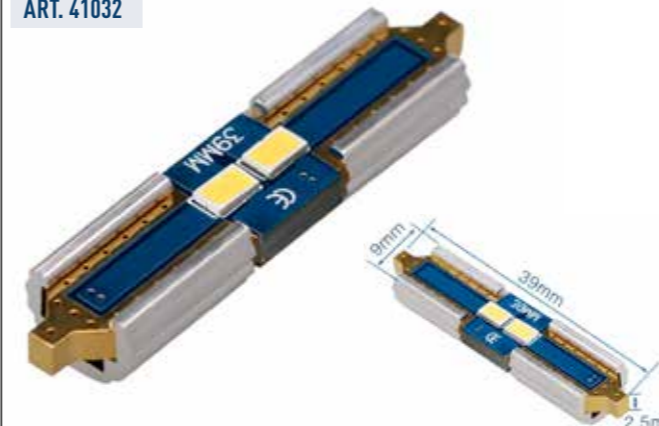

- CN2\*3623SMD
  - LED SAMSUNG
  - CANBUS
  - 160±10MA
  - NON-POLARITY
  - 12V-14.5V
  - 39MM
  - 100LM
  - WHITE 5500K
- LAMPADA DI POSIZIONE A LED
  - SILURO 39MM
  - CAN BUS NO ERROR
  - 12 VOLT
  - LUCE BIANCA FREDDA 5500K
  - 2 LED ALTA LUMINOSITA'
  - T11

**ART. 41033**

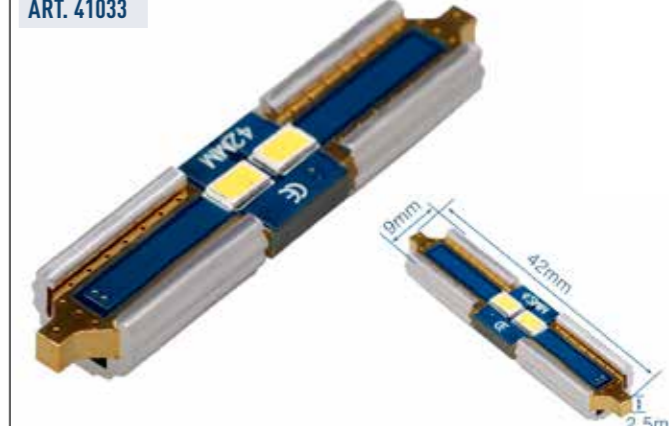

- 2\*3623SMD
  - LED SAMSUNG
  - CANBUS
  - 160±10MA
  - NON-POLARITY
  - 12V-14.5V
  - 42MM
  - 100LM
  - WHITE 5500K
- LAMPADA DI POSIZIONE A LED
  - SILURO 42MM
  - CAN BUS NO ERROR
  - 12 VOLT
  - LUCE BIANCA FREDDA 5500K
  - 2 LED ALTA LUMINOSITA'
  - T11



**LED.GOLDH8C8**



- 8\*3623SMD
- LED SAMSUNG
- CAN BUS
- 680±20MA
- NON-POLARITY
- CONSTANT CURRENT IC
- SURGE VOLTAGE 18V
- 12V-16.5V
- H8
- LAMPADA A LED
- H8
- CAN BUS NO ERROR
- 12 VOLT
- 8 LED ALTA LUMINOSITA'
- 550LM
- WHITE 5500K

**LED.GOLDH11C8**



- 8\*3623SMD
- LED SAMSUNG
- CAN BUS
- 680±20MA
- NON-POLARITY
- CONSTANT CURRENT IC
- SURGE VOLTAGE 18V
- 12V-16.5V
- H11
- LAMPADA A LED H11
- CAN BUS NO ERROR
- 12 VOLT
- 8 LED ALTA LUMINOSITA'
- 550LM
- WHITE 5500K

**LED.GOLDH7C8**

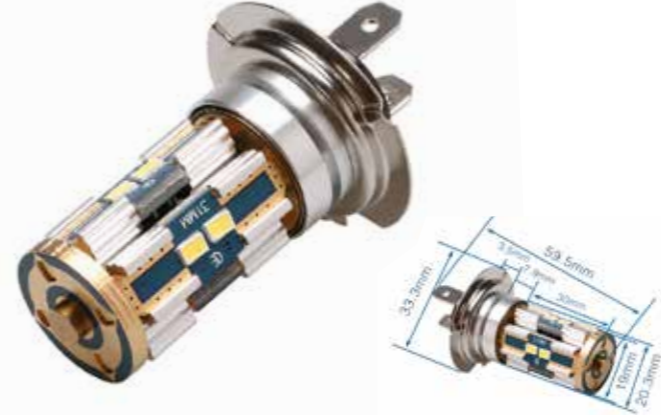

- 8\*3623SMD
- LED SAMSUNG
- CAN BUS
- 680±20MA
- NON-POLARITY
- CONSTANT CURRENT IC
- SURGE VOLTAGE 18V
- 12V-16.5V
- H7
- LAMPADA A LED
- H7
- CAN BUS NO ERROR
- 12 VOLT
- 8 LED ALTA LUMINOSITA'
- 550LM
- WHITE 5500K

**LED.GOLDH16C8**



- 8\*3623SMD
- LED SAMSUNG
- CAN BUS
- 680±20MA
- NON-POLARITY
- CONSTANT CURRENT IC
- SURGE VOLTAGE 18V
- 12V-16.5V
- H16
- LAMPADA A LED
- H16
- CAN BUS NO ERROR
- 12 VOLT
- 8 LED ALTA LUMINOSITA'
- 550LM
- WHITE 5500K

**LED.GOLDH9C8**



- 8\*3623SMD
- LED SAMSUNG
- CAN BUS
- 680±20MA
- NON-POLARITY
- CONSTANT CURRENT IC
- SURGE VOLTAGE 18V
- 12V-16.5V
- H9
- LAMPADA A LED
- H9
- CAN BUS NO ERROR
- 12 VOLT
- 8 LED ALTA LUMINOSITA'
- 550LM
- WHITE 5500K

**LED.GOLDHB3C8**



- 8\*3623SMD
- LED SAMSUNG
- CAN BUS
- 680±20MA
- NON-POLARITY
- CONSTANT CURRENT IC
- SURGE VOLTAGE 18V
- 12V-16.5V
- 9005
- LAMPADA A LED HB3 9005
- CAN BUS NO ERROR
- 12 VOLT
- 8 LED ALTA LUMINOSITA'
- 550LM
- WHITE 5500K

**LED.GOLDHB4C8**



- 8\*3623SMD
- LED SAMSUNG
- CAN BUS
- 680±20MA
- NON-POLARITY
- CONSTANT CURRENT IC
- SURGE VOLTAGE 18V
- 12V-16.5V
- 9006
- LAMPADA A LED
- HB4 9006
- CAN BUS NO ERROR
- 12 VOLT
- 8 LED ALTA LUMINOSITA'
- 550LM
- WHITE 5500K





**SENZA POLARITÀ**

Built in constant current IC can keep the current and voltage stable

“ With safety canbus, it can be installed on most of the luxury cars directly and it works well. Nonpolar and plug and play. ”

**ART. 41101**

- CAN BUS
- POWER: 5W
- COLOR: WHITE 5500 K
- LED QUANTITY: 6PCS
- VOLTAGE: DC10V-16V
- BEAM ANGLE: 180°
- USAGE: READING LIGHT, MIRROR LIGHT, LICENSE PLATE LIGHT, WIDTH LIGHT

- LAMPADE DI POSIZIONE A LED
- T10
- CAN BUS NO ERROR
- 12 VOLT
- LUCE BIANCA FREDDA 5500K
- 6 LED ALTA LUMINOSITA'
- W5W (TUTTO VETRO)

**ART. 41130**

- CAN BUS
- POWER: 5W
- COLOR: WHITE
- LED QUANTITY: 6PCS
- VOLTAGE: DC10V-16V
- BEAM ANGLE: 180°
- USAGE: READING LIGHT, MIRROR LIGHT, LICENSE PLATE LIGHT, TRUCK LIGHT

- LAMPADE DI POSIZIONE A LED
- CAN BUS NO ERROR
- 12 VOLT
- LUCE BIANCA FREDDA 5500K
- 6 LED ALTA LUMINOSITA'
- SILURO 31 MM

**ART. 41131**

- CAN BUS
- POWER: 5W
- COLOR: WHITE
- LED QUANTITY: 6PCS
- VOLTAGE: DC10V-16V
- BEAM ANGLE: 180°
- USAGE: READING LIGHT, MIRROR LIGHT, LICENSE PLATE LIGHT, TRUCK LIGHT

- LAMPADE DI POSIZIONE A LED
- CAN BUS NO ERROR
- 12 VOLT
- LUCE BIANCA FREDDA 5500K
- 6 LED ALTA LUMINOSITA'
- SILURO 36 MM

**ART. 41132**

- CAN BUS
- POWER: 5W
- COLOR: WHITE
- LED QUANTITY: 6PCS
- VOLTAGE: DC10V-16V
- BEAM ANGLE: 180°
- USAGE: READING LIGHT, MIRROR LIGHT, LICENSE PLATE LIGHT, TRUCK LIGHT

- LAMPADE DI POSIZIONE A LED
- CAN BUS NO ERROR
- 12 VOLT
- LUCE BIANCA FREDDA 5500K
- 6 LED ALTA LUMINOSITA'
- SILURO 39 MM

**ART. 41133**

- CAN BUS
- POWER: 5W
- COLOR: WHITE
- LED QUANTITY: 6PCS
- VOLTAGE: DC10V-16V
- BEAM ANGLE: 180°
- USAGE: READING LIGHT, MIRROR LIGHT, LICENSE PLATE LIGHT, TRUCK LIGHT

- LAMPADE DI POSIZIONE A LED
- CAN BUS NO ERROR
- 12 VOLT
- LUCE BIANCA FREDDA 5500K
- 6 LED ALTA LUMINOSITA'
- SILURO 41 MM

**ART. 41155**

- CAN BUS
- POWER: 15W
- COLOR: WHITE
- LED QUANTITY: 10PCS
- VOLTAGE: DC10V-16V
- BEAM ANGLE: 360°
- USAGE: READING LIGHT, MIRROR LIGHT, LICENSE PLATE LIGHT, TRUCK LIGHT

- LAMPADE DI POSIZIONE/RETROMARCIA A LED
- CAN BUS NO ERROR
- 12 VOLT
- LUCE BIANCA FREDDA 5500K
- 10 LED ALTA LUMINOSITA'



ART. 41160



**SINGOLO FILAMENTO**

- POWER: 28W
- INPUT (MA): 750±20
- LUMENS (LM): 760
- LED QUANTITY: 14PCS
- VOLTAGE: DC10V-16V
- PCB: ALUMINUM SUBSTRATE
- BEAM ANGLE: 360°
- USAGE: BACK-UP LIGHT, TURNING LIGHT, TAIL LIGHT
- WHITE 5500K
- LAMPADA DI POSIZIONE A LED
- BA15S - 1156 - P21W
- SINGOLO FILAMENTO
- CAN BUS NO ERROR
- 12 VOLT
- LUCE BIANCA FREDDA 5500K
- 14 LED ALTA LUMINOSITA'

ART. 41161

**DOPIO FILAMENTO**



- POWER: 28W
- INPUT (MA): H:750±20 L:160±20
- LUMENS (LM): 760
- LED QUANTITY: 14PCS
- VOLTAGE: DC10V-16V
- PCB: ALUMINUM SUBSTRATE
- BEAM ANGLE: 360°
- USAGE: BRAKE LIGHT, DRL
- WHITE 5500K
- LAMPADA DI POSIZIONE A LED
- BAY15D - 1157 - P21W/5W
- DOPIO FILAMENTO
- CAN BUS NO ERROR
- 12 VOLT
- LUCE BIANCA FREDDA 5500K
- 14 LED ALTA LUMINOSITA'

ART. 41174



- POWER: 28W
- INPUT (MA): 760±20
- LUMENS (LM): 760
- LED QUANTITY: 14PCS
- VOLTAGE: DC10V-16V
- PCB: ALUMINUM SUBSTRATE
- BEAM ANGLE: 360°
- USED: FRONT FOG LIGHTS
- WHITE 5500K
- LAMPADA A LED
- H11-H8
- CAN BUS NO ERROR
- 12 VOLT
- LUCE BIANCA FREDDA 5500K
- 14 LED ALTA LUMINOSITA'

LED.PROHB3C14



- POWER: 28W
- INPUT (MA): 760±20
- LUMENS (LM): 760
- LED QUANTITY: 14PCS
- VOLTAGE: DC10V-16V
- PCB: ALUMINUM SUBSTRATE
- BEAM ANGLE: 360°
- USED: FRONT FOG LIGHTS
- WHITE 5500K
- LAMPADA A LED
- HB3 9005
- CAN BUS NO ERROR
- 12 VOLT
- LUCE BIANCA FREDDA 5500K
- 14 LED ALTA LUMINOSITA'

ART. 41150



**SINGOLO FILAMENTO**

- POWER: 28W
- INPUT (MA): 750±20
- LUMENS (LM): 760
- LED QUANTITY: 14PCS
- VOLTAGE: DC10V-16V
- PCB: ALUMINUM SUBSTRATE
- BEAM ANGLE: 360°
- USAGE: BACK-UP LIGHT, TURNING LIGHT, TAIL LIGHT
- WHITE 5500K
- LAMPADA DI POSIZIONE A LED
- T20 - 7440 - W21W
- SINGOLO FILAMENTO
- CAN BUS NO ERROR
- 12 VOLT
- LUCE BIANCA FREDDA 5500K
- 14 LED ALTA LUMINOSITA'

ART. 41151



**DOPIO FILAMENTO**

- POWER: 28W
- INPUT (MA): H:750±20 L:160±20
- LUMENS (LM): 760
- LED QUANTITY: 14PCS
- VOLTAGE: DC10V-16V
- PCB: ALUMINUM SUBSTRATE
- BEAM ANGLE: 360°
- USAGE: BRAKE LIGHT, DRL
- WHITE 5500K
- LAMPADA DI POSIZIONE A LED
- T20 - 7443 - W21/5W
- DOPIO FILAMENTO
- CAN BUS NO ERROR
- 12 VOLT
- LUCE BIANCA FREDDA 5500K
- 14 LED ALTA LUMINOSITA'

LED.PROHB4C14

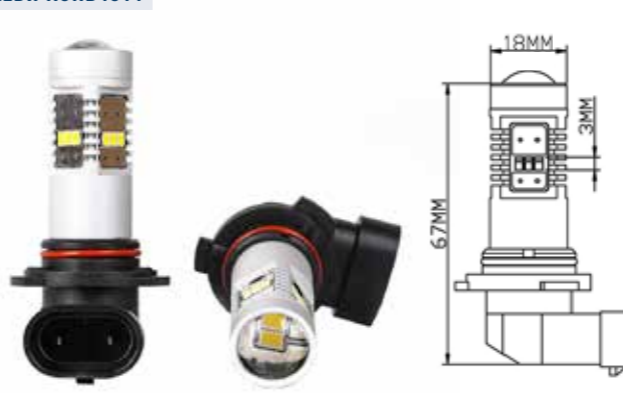

- POWER: 28W
- INPUT (MA): 760±20
- LUMENS (LM): 760
- LED QUANTITY: 14PCS
- VOLTAGE: DC10V-16V
- PCB: ALUMINUM SUBSTRATE
- BEAM ANGLE: 360°
- USED: FRONT FOG LIGHTS
- WHITE 5500K
- LAMPADA A LED
- HB4 9006
- CAN BUS NO ERROR
- 12 VOLT
- LUCE BIANCA FREDDA 5500K
- 14 LED ALTA LUMINOSITA'

ART. 43173

PSX24W



**LUCE FREDDA 6000K**

- INPUT (MA): H 450±20 - L 100±20
- 12/24 VOLT
- LUMENS (LM): 800
- LED QUANTITY: 13 SMD
- PCB: ALUMINUM SUBSTRATE
- BEAM ANGLE: 360°
- LAMPADA DI POSIZIONE A LED
- USAGE: BACK-UP LIGHT, TURNING LIGHT, TAIL LIGHT
- T20/21-5W - 7443 - W21/5W
- DOPIO FILAMENTO
- CAN BUS NO ERROR
- LUCE BIANCA FREDDA 6000K

ART. 41152



- POWER: 28W
- INPUT (MA): 750±20
- LUMENS (LM): 760
- LED QUANTITY: 14PCS
- VOLTAGE: DC10V-16V
- PCB: ALUMINUM SUBSTRATE
- BEAM ANGLE: 360°
- USAGE: BACK-UP LIGHT, TURNING LIGHT, TAIL LIGHT
- YELLOW
- LAMPADA FRECCHE A LED
- T20 - 7440 - W21W
- SINGOLO FILAMENTO
- CAN BUS NO ERROR
- 12 VOLT
- LUCE ARANCIO
- 14 LED ALTA LUMINOSITA'

ART. 41173- 1 coppia

PSX24W



1. POWER: 28W
2. INPUT (MA): 760±20
3. LUMENS (LM): 760
4. LED QUANTITY: 14PCS
5. VOLTAGE: DC10V-16V
6. PCB: ALUMINUM SUBSTRATE
7. BEAM ANGLE: 360°
8. USED: FRONT FOG LIGHTS
- WHITE 5500K
- LAMPADA A LED
- PSX24
- CAN BUS NO ERROR
- 12 VOLT
- LUCE BIANCA FREDDA 5500K
- 14 LED ALTA LUMINOSITA'

ART. 41170 - 1 coppia

PW24W  
PWY24W



- POWER: 50W
- INPUT (MA): 760±20
- LUMENS (LM): 760
- LED QUANTITY: 10 PCS CREE DA 5W
- VOLTAGE: DC10V-16V
- PCB: ALUMINUM SUBSTRATE
- BEAM ANGLE: 360°
- USED: FRONT FOG LIGHTS
- WHITE 6000K
- LAMPADA A LED
- PW24W - PWY24W
- CAN BUS NO ERROR
- 12 VOLT
- LUCE BIANCA FREDDA 6000K
- 10 LED ALTA LUMINOSITA'

ART. 41201  
CAN BUS NO ERROR



- QUESTO MODELLO NON DA ERRORE AL COMPUTER DI BORDO
- BASE T10 W5W (TUTTO VETRO)
- UTILIZZO LUCI DI POSIZIONE, LUCI DI CORTESIA ETC ETC
- 8 LED SMD
- LUCE FRONTALE E LATERALE
- ILLUMINAZIONE BIANCO GHIACCIO 6000K - 12 VOLT

ART. 41202  
CAN BUS NO ERROR



- QUESTO MODELLO NON DA ERRORE AL COMPUTER DI BORDO
- BASE T10 W5W (TUTTO VETRO)
- UTILIZZO LUCI DI POSIZIONE, LUCI DI CORTESIA ETC ETC - 5 GRANDI LED SMD "5050"
- LUCE FRONTALE E LATERALE
- ILLUMINAZIONE BIANCO GHIACCIO 6000K
- 12 VOLT

ART. 41212



- BASE T10 W5W (TUTTO VETRO)
- UTILIZZO LUCI DI POSIZIONE, LUCI DI CORTESIA, LUCI TARGA ETC ETC - 5 LED SMD 5050
- 3 CHIP
- LUCE FRONTALE E LATERALE
- ILLUMINAZIONE BIANCO GHIACCIO 6000K.
- 12 VOLT

ART. 41213



- BASE T10 W5W (TUTTO VETRO)
- UTILIZZO LUCI DI POSIZIONE, LUCI DI CORTESIA ETC.
- 8 LED SMD - INTENSA LUCE FRONTALE
- ILLUMINAZIONE BIANCO GHIACCIO 6000K.
- 12 VOLT

ART. 41235 - CAN BUS NO ERROR



- 39 mm
- QUESTO MODELLO NON DA ERRORE AL COMPUTER DI BORDO
- BASE T11 C5W (SILURO 39 mm)
- UTILIZZO LUCI TARGA, LUCI DI CORTESIA, LUCI DI POSIZIONE ETC ETC
- 3 LED SMD "5050" - LUCE FRONTALE
- ILLUMINAZIONE BIANCO GHIACCIO 6000K - 12 VOLT

ART. 41260 - CAN BUS NO ERROR



- QUESTO MODELLO NON DA ERRORE AL COMPUTER DI BORDO
- NON SEGNA ERRORE SU 12V 5W
- BASE BA15S G18,5
- UTILIZZO LUCI DI POSIZIONE, LUCI DI CORTESIA, ETC ETC
- LUCI DIURNE AUDI (NO ERROR)
- 7 GRANDI LED SMD "5050"
- LUCE FRONTALE E LATERALE
- ILLUMINAZIONE BIANCO GHIACCIO 6000K - 12 VOLT - 5 WATT

ART. 41270



- BASE H1
- UTILIZZO ESTETICO: LUCI FENDINEBBIA DECORATIVE, LUCI DIURNE
- 13 LED SMD 5050 - 3 CHIP
- LUCE FRONTALE E LATERALE
- ILLUMINAZIONE BIANCO FREDDO 6000K, COME GLI XENON
- BASSO CONSUMO: 1,8 WATT
- LUNGA DURATA
- 12 VOLT

ART. 41271



- BASE H3
- UTILIZZO ESTETICO: LUCI FENDINEBBIA DECORATIVE, LUCI DIURNE - 13 LED SMD 5050
- 3 CHIP
- LUCE FRONTALE E LATERALE
- ILLUMINAZIONE BIANCO FREDDO 6000K, COME GLI XENON
- BASSO CONSUMO: 1,8 WATT - LUNGA DURATA - 12 VOLT

ART. 41200 - CAN BUS NO ERROR



- LAMPADA T5 DA CRUSCOTTO
- QUESTO MODELLO NON DA ERRORE AL COMPUTER DI BORDO
- BASE T5
- UTILIZZO LUCI CRUSCOTTO
- 2 LED SMD "5050"
- ILLUMINAZIONE BIANCO GHIACCIO 6000K - 12 VOLT



LED.S369 (luce bianca fredda)



- SILURO 36 mm
- BASE T11 C5W
- UTILIZZO: LUCI TARGA, LUCI ABITACOLO
- 6 LED SMD - LUCE FRONTALE
- ILLUMINAZIONE BIANCO FREDDO 6000K (COME GLI XENON), BLU, ROSSA
- BASSO CONSUMO: SOLTANTO 1,2 WATT
- LUNGA DURATA - 12 VOLT



ART. 41280

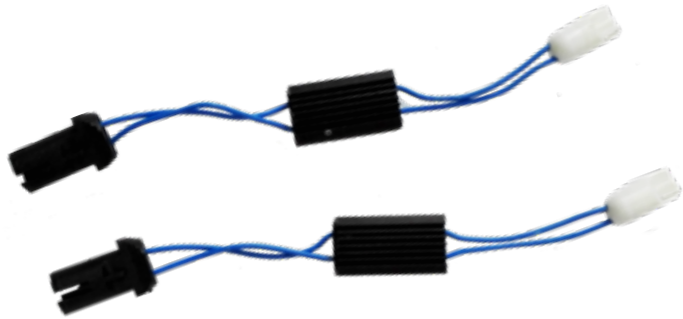

- RESISTENZE PER LAMPADINE A LED STANDARD BASE "TUTTO VETRO"
- T10 W5W
- 12 VOLT
- 1 COPPIA

ART. 41282



- COPPIA RESISTENZE PER SIMULARE UN CARICO DA 21 WATT A 12 VOLT

LD.T5 1B (LUCE BLU)  
LED.T5 1R (LUCE ROSSA)  
LED.T5 1G (LUCE VERDE)  
LED.T5 1Y (LUCE GIALLA)



- BASE T5 W1,2W
- UTILIZZO LUCI CRUSCOTTO, STRUMENTAZIONE, CONTORNO FARI TUNING ETC ETC
- 1 LED SMD 5050
- 3 CHIP
- LUCE FRONTALE
- ILLUMINAZIONE BIANCO GHIACCIO 6000K. BLU, ROSSA, VERDE O GIALLA
- 12/24 VOLT

ART. 41281



- COPPIA RESISTENZE PER SIMULARE UN CARICO DA 5 WATT A 12 VOLT

LED.T5B 1W (LUCE BIANCA FREDDA)  
LED.T5B 1B (LUCE BLU)  
LED.T5B 1R (LUCE ROSSA)  
LED.T5B 1G (LUCE VERDE)  
LED.T5B 1Y (LUCE GIALLA)



- BASE T5 B8,5D
- UTILIZZO LUCI CRUSCOTTO, STRUMENTAZIONE, CONTORNO FARI TUNING ETC ETC
- 1 LED SMD 5050
- 3 CHIP
- LUCE FRONTALE
- ILLUMINAZIONE BIANCO GHIACCIO 6000K. BLU, ROSSA, VERDE O GIALLA
- 12/24 VOLT

LED.24VT5B 1W (LUCE BIANCA FREDDA)  
LED.24VT5B 1B (LUCE BLU)

ART. 41200 - CAN BUS NO ERROR



- LAMPADA T5 DA CRUSCOTTO
- QUESTO MODELLO NON DA ERRORE AL COMPUTER DI BORDO
- BASE T5
- UTILIZZO LUCI CRUSCOTTO
- 2 LED SMD "5050"
- ILLUMINAZIONE BIANCO GHIACCIO 6000K - 12 VOLT



ART. 41070



- LAMPADA A LED PER ANGEL EYES ULTRA BIANCA
- 10 WATT LED CREE
- COMPATIBILITÀ:
  - E87 1-SERIES (2004-2007 MODELS)
  - E39 5-SERIES (2001-2003 MODELS)
  - E60 E61 5-SERIES (2004-2007 MODELS - SOLO CON MODELLI HID XENON DI SERIE)
  - E63 E64 6-SERIES (2004-2007 MODELS)
  - E65 E66 7-SERIES (2002-2007 MODELS)
  - E53 X5-SERIES (2004-2006 MODELS)
  - X SERIES: E83 X3 2007 IN POI
- SPECIFICHE TECNICHE:
  - VOLTAGGIO: 12V;
  - POTENZA DI CONSUMO PER OGNI LAMPADA A LED: 10W;
  - COLORAZIONE: 5500K-6500K (BIANCO GHIACCIO)



ART. 41071



- LAMPADA A LED PER ANGEL EYES ULTRA BIANCA
- 40 WATT LED CREE
- COMPATIBILITÀ:
  - BMW E90 E91 (FINO AL 2008)
  - BMW X5 (DAL 2010 IN POI)
- SPECIFICHE TECNICHE:
  - VOLTAGGIO: 12V;
  - POTENZA DI CONSUMO PER OGNI LAMPADA LED: 40W;
  - COLORAZIONE: 5500K-6500K
  - COLORE: BIANCO GHIACCIO



ART. 40603



4500LM

ART. 40553 ENTRY LEVEL



4500LM

- LAMPADA A LED PER ANGEL EYES ULTRA BIANCA
- COMPATIBILITÀ:
  - SERIE 1: E82,E87 COUPE,HATCHBACK 2008 IN POI
  - SERIE 3: E90,E91,E92,E93 2008,9 IN POI
  - SERIE 5: E60,E61 (FACELIFT)2007,05 IN POI
  - SERIE 6: E63 E64 2007,07 IN POI
  - SERIE X: E70,E71 DAL 2007 IN POI
  - SERIE Z: E89 Z4
  - X1:E84
- ATTACCO: H8



ART. 40050



- KIT LUCI TARGA PERSONALIZZATO GOLF IV,V, SEAT IBIZA**
- VW GOLF4 1997-2005
  - GOLF5 2003-2008
  - Lupo 1998-2005
  - Polo 9N 2001-2009
  - Passat 3c B6 Limousine 2005-2010
  - SEAT Ibiza 2012



ART. 40051



- KIT LUCI TARGA PERSONALIZZATO AUDI Q5 A4 A5 A6 A7 TT RS TTRS, VW GOLF V VI**
- AUDI Q5 '08-'10 A4 4D/5D '08-'10 S5 '08-'10 A5 '07-'10 TT '07- A6 2011- A7 2011- TT/TTTS 2011- R55 2012- TTRS 2011-
  - VW GOLF 6 PLUS 2009- GOLF 6 VARIANT 5D 2009- JETTA MK6 2011-
  - VW PASSAT 5D '08-'09/PASSAT 5D R36 '08-'09 POLO 4D SEDAN 2010- /PASSAT
  - B6 (4D or 5D) 2009- /PASSAT B7 5D WAGON 2011- /
  - VW SHARAN 2011- TOURAN 2011- TOUAREG 2011-



ART. 40052



- KIT LUCI TARGA PERSONALIZZATO AUDI A1 A6, VW GOLF VI, SEAT IBIZA**
- AUDI A1 2011- A6 2011- A6Q 2011- A7 2011-TT/TTTS 2011- R55 2012- TTRS 2011-
  - VW GOLF 6 PLUS 2009- GOLF 6 VARIANT 5D 2009-
  - VW JETTA MK6 2011- PASSAT B6 (4D OR 5D) 2009-
  - VW PASSAT B7 5D WAGON 2011-
  - VW POLO 4D Sedan 2010- SHARAN 2011-
  - VW TOURAN 2011- TOUAREG 2011-



ART. 40062



- KIT LUCI TARGA PERSONALIZZATO MERCEDES, SMART**
- Mercedes Benz Smart Viano Vito
  - Smart
  - Voltaggio: 12V;
  - Potenza di consumo per ogni lampada a led: 3W;
  - Colorazione: 6000K (Bianco Ghiaccio)



ART. 40063



- KIT LUCI TARGA PERSONALIZZATO FORD, JAGUAR**
- Ford Focus 5d Dopo 2009
  - Ford Mondeo Dopo 2008
  - Ford Fiesta Dopo 2009
  - Jaguar XF 2009
  - Voltaggio: 12V;



ART. 40064



- KIT LUCI TARGA PERSONALIZZATO FORD**
- Ford Focus C-MAX Dopo 2003
  - Ford Focus MK2 2003-2008
  - Compatibile con codice articoli FORD: 4 502 331 e 4 502 332
  - Voltaggio: 12V;
  - Potenza di consumo per ogni lampada a led: 5W



ART. 40053



- KIT LUCI TARGA PERSONALIZZATO AUDI A1 S LINE DOPO 2011, VW PASSAT, PORSCHE PANAMERA**
- AUDI A1 S Line Dopo 2011
  - AUDI Q5 [2008-2010] A4 4D/5D [2008-2010]
  - AUDI S5 [2008-2010] A5 [2007-2010] TT [2007-2010]
  - VW Passat 5D [2008-2010]
  - VW Passat 5D R36 [2008-2010]
  - Porsche Panamera 4D [Dopo 2010]



ART. 40054



- KIT LUCI TARGA PERSONALIZZATO VW, PORSCHE**
- Porsche Cayenne 2002-2010 (\*OEM part no. 95563162002; Chassis model 9PA / 9PA1)
  - VW Touareg 2003-2010 (\*with space-saving spare wheel)
  - VW Tiguan
  - VW Golf 5 5D touring
  - VW Passat [B5.5] 5D touring



ART. 40055



- KIT LUCI TARGA PERSONALIZZATO FIAT 500X**
- Fiat 500X
  - Ford Falcon
  - Voltaggio: 12V;
  - Potenza di consumo per ogni lampada a led: 5W;
  - Colorazione: 6000K (Bianco Ghiaccio)



ART. 40065



- KIT LUCI TARGA PERSONALIZZATO OPEL,CHEVROLET**
- Chevrolet Camaro Cruze
  - Opel Insignia Mokka 2012
  - Voltaggio: 12V;
  - Potenza di consumo per ogni lampada a led: 3W;
  - Luminosità 200 Lumen



ART. 40066



- KIT LUCI TARGA PERSONALIZZATO OPEL**
- Opel Astra J
  - Opel Zafira-C
  - Voltaggio: 12V;
  - Potenza di consumo per ogni lampada a led: 3W;
  - Luminosità 200 Lumen



ART. 40067



- KIT LUCI TARGA PERSONALIZZATO SMART FORTWO**
- Smart Fortwo
  - Voltaggio: 12V;
  - Potenza di consumo per ogni lampada a led: 5W;
  - Colorazione: 6000K (Bianco Ghiaccio)



ART. 40056



- KIT LUCI TARGA PERSONALIZZATO FIAT 500L, ALFA ROMEO MITO, GIULIETTA, OPEL, MINI**
- Compatibile con luci targa Codice OEM Fiat 51762788-
  - Opel Zafira B 05-11,
  - Opel Astra H 04-09,
  - Opel Corsa D 06-11,
  - Opel Insignia Dopo 2008
  - Fiat Grande Punto 1,3 Multijet 2005



ART. 40057



- KIT LUCI TARGA PERSONALIZZATO FIAT 500**
- Fiat 500 500C Con OEM Part Number 51800482
  - Voltaggio: 12V;
  - Potenza di consumo per ogni lampada a led: 3W;
  - Colorazione: 6000K (Bianco Ghiaccio)
  - LUMINOSITÀ 200 Lumen



ART. 40058



- KIT LUCI TARGA PERSONALIZZATO BMW, ALFA ROMEO**
- BMW E63, E63N, E64, E64N
  - BMW E81, E87, E87N (Prima del 09-2007)
  - BMW E85 (Z4 roadster), E86 (Z4 coupe)
  - Mini R55



ART. 40068



- KIT LUCI TARGA PERSONALIZZATO RENAULT**
- RENAULT Twingo
  - RENAULT Clio 3D 2006.09
  - RENAULT Clio 5D 2006.09
  - RENAULT Megane 3D 2006.02
  - RENAULT Megane 5D 2006.02
  - RENAULT Megane kombi



ART. 40069



- KIT LUCI TARGA PERSONALIZZATO PEUGEOT CITROEN**
- PEUGEOT:
  - 106 Facelift 1997-2004
  - 1007
  - 207
  - 307
  - 308



ART. 40070



- KIT LUCI TARGA PERSONALIZZATO MINI**
- MINI COOPER R56
  - Voltaggio: 12V;
  - Potenza di consumo per ogni lampada a led: 5W;
  - Colorazione: 6000K (Bianco Ghiaccio)



ART. 40059



- KIT LUCI TARGA PERSONALIZZATO BMW CON PLAFONIERA LED DI SERIE**
- BMW E87 LCI E63LCI E46 LCI E89 F20 F12 F13 Con Plafoniera Led Di Serie
  - N.OEM 63267193294-
  - Voltaggio: 12V;
  - Potenza di consumo per ogni lampada a led: 5W;
  - Colorazione: 6000K (Bianco Ghiaccio)



ART. 40060



- KIT LUCI TARGA PERSONALIZZATO BMW**
- BMW E82 E88 E70 E71 E90 E90N E91 E92 E93 M3 CSL E39 E46 E60 E60N E61
  - E61N
  - Voltaggio: 12V;
  - Potenza di consumo per ogni lampada a led: 5W;
  - Colorazione: 6000K (Bianco Ghiaccio)



ART. 40061



- KIT LUCI TARGA PERSONALIZZATO MERCEDES**
- Mercedes Benz ML350 W251 R300 S400 R500 ML400 GL450 GL500
  - OEM Parts Number: A 251 820 00 66
  - Voltaggio: 12V;
  - Potenza di consumo per ogni lampada a led: 3W;
  - Colorazione: 6000K (Bianco Ghiaccio)



ART. 40071



- KIT LUCI TARGA PERSONALIZZATO AUDI**
- Audi Q7 2007 2009;
  - Audi S6 2005 2009;
  - Audi A3 Cabriolet 2009;
  - Audi RS4 Avant Quattro 2006 2008;
  - Audi RS4 Cabriolet 2006 2008;
  - Audi RS6 Plus Avant 2008 2009;



ART. 40072



- KIT LUCI TARGA PERSONALIZZATO VW**
- VW EOS 2006-2015 - Lupo 1998+2006
  - VW Amarok 2008- - Bora 1998-2005
  - VW Golf4 1997-2005 - Golf5 2003-2008
  - VW Golf6 2008-2012 - Golf7 2012.10
  - VW New beetle facelift 2006-2010
  - VW passat 3C B6 B7 2005-2010
  - VW passat CC 2008- - Phaeton 2002-2016
  - VW polo (6N2) 1999-2001 - Polo(9N) 2001-2009
  - VW polo (6R) 2009- - Scirocco3 2008





ART. 40752



TRUCK

H7

24V

**KIT A LED H7 24 VOLT SPECIFICO TRUCK** (2 PCS.)

- LED POWER: 48W (SINGLE)
- COMPONENTE LED CHIP ZES DI ELEVATA EFFICIENZA E QUALITÀ, STUDIATO SPECIFICAMENTE PER KIT A LED TRUCK
- PRODOTTO IN ALLUMINIO 6063
- DOPPIO DISSIPATORE DEL CALORE CON VENTOLA
- DC 24 VOLT
- WATERPROOF: IP68
- 6000LM (LUMEN)
- TEMPERATURA COLORE: 6000K
- LIFETIME: >30.000 ORE
- TEMPERATURA OPERATIVA: DA -45°C A +120°C
- ANGOLO FASCIO D'ILLUMINAZIONE REGOLABILE A 360°

ART. 40751



TRUCK

H4

24V

**KIT A LED H4 24 VOLT SPECIFICO TRUCK** (2 PCS.)

- LED POWER: 48W (HIGH/LOW)
- COMPONENTE LED CHIP ZES DI ELEVATA EFFICIENZA E QUALITÀ, STUDIATO SPECIFICAMENTE PER KIT A LED TRUCK
- PRODOTTO IN ALLUMINIO 6063
- DOPPIO DISSIPATORE DEL CALORE CON VENTOLA
- DC 24 VOLT
- WATERPROOF: IP68
- 6000LM (LUMEN)
- TEMPERATURA COLORE: 6000K
- LIFETIME: >30.000 ORE
- TEMPERATURA OPERATIVA: DA -45°C A +120°C
- ANGOLO FASCIO D'ILLUMINAZIONE REGOLABILE A 360°

ART. 40753



TRUCK

H11

24V

**KIT A LED H11 24 VOLT SPECIFICO TRUCK** (2 PCS.)

- LED POWER: 48W (SINGLE)
- COMPONENTE LED CHIP ZES DI ELEVATA EFFICIENZA E QUALITÀ, STUDIATO SPECIFICAMENTE PER KIT A LED TRUCK
- PRODOTTO IN ALLUMINIO 6063
- DOPPIO DISSIPATORE DEL CALORE CON VENTOLA
- DC 24 VOLT
- WATERPROOF: IP68
- 6000LM (LUMEN)
- TEMPERATURA COLORE: 6000K
- LIFETIME: >30.000 ORE
- TEMPERATURA OPERATIVA: DA -45°C A +120°C
- ANGOLO FASCIO D'ILLUMINAZIONE REGOLABILE A 360°

ART. 43160



12/24 Volt

LUCE FREDDA 6000K

SINGOLO FILAMENTO

- INPUT (MA): 450±20
- 12/24 VOLT
- LUMENS (LM): 800
- LED QUANTITY: 13 SMD
- PCB: ALUMINUM SUBSTRATE
- BEAM ANGLE: 360°
- LAMPADA DI POSIZIONE A LED

- USAGE: BACK-UP LIGHT, TURNING LIGHT, TAIL LIGHT
- BA15S - 1156 - P21W
- SINGOLO FILAMENTO
- CAN BUS NO ERROR
- LUCE BIANCA FREDDA 6000K

ART. 43150



12/24 Volt

LUCE FREDDA 6000K

SINGOLO FILAMENTO

- INPUT (MA): 450±20
- 12/24 VOLT
- LUMENS (LM): 800
- LED QUANTITY: 13 SMD
- PCB: ALUMINUM SUBSTRATE
- BEAM ANGLE: 360°
- LAMPADA DI POSIZIONE A LED

- USAGE: BACK-UP LIGHT, TURNING LIGHT, TAIL LIGHT
- T20 - 7440 - W21W
- SINGOLO FILAMENTO
- CAN BUS NO ERROR
- LUCE BIANCA FREDDA 6000K

ART. 43162



12/24 Volt

LUCE FRECCE COLOR ARANCIONE

SINGOLO FILAMENTO

- INPUT (MA): 450±20
- 12/24 VOLT
- LUMENS (LM): 800
- LED QUANTITY: 13 SMD
- PCB: ALUMINUM SUBSTRATE
- BEAM ANGLE: 360°
- LAMPADA FRECCE A LED

- USAGE: BACK-UP LIGHT, TURNING LIGHT, TAIL LIGHT
- PY21W - S25 - BAU15S
- SINGOLO FILAMENTO
- CAN BUS NO ERROR
- LUCE ARANCIONE FRECCE

ART. 43161



12/24 Volt

LUCE FREDDA 6000K

DOPPIO FILAMENTO

- INPUT (MA): H 450±20 - L 100±20
- 12/24 VOLT
- LUMENS (LM): 800
- LED QUANTITY: 13 SMD
- PCB: ALUMINUM SUBSTRATE
- BEAM ANGLE: 360°
- LAMPADA DI POSIZIONE A LED

- USAGE: BACK-UP LIGHT, TURNING LIGHT, TAIL LIGHT
- BAY15D - 1157 - P21W/5W
- DOPPIO FILAMENTO
- CAN BUS NO ERROR
- LUCE BIANCA FREDDA 6000K

ART. 43151



12/24 Volt

LUCE FREDDA 6000K

DOPPIO FILAMENTO

- INPUT (MA): H 450±20 - L 100±20
- 12/24 VOLT
- LUMENS (LM): 800
- LED QUANTITY: 13 SMD
- PCB: ALUMINUM SUBSTRATE
- BEAM ANGLE: 360°
- LAMPADA DI POSIZIONE A LED

- USAGE: BACK-UP LIGHT, TURNING LIGHT, TAIL LIGHT
- T20/21-5W - 7443 - W21/5W
- DOPPIO FILAMENTO
- CAN BUS NO ERROR
- LUCE BIANCA FREDDA 6000K

ART. 43163



12/24 Volt

LUCE POSIZIONE/STOP COLOR ROSSO

DOPPIO FILAMENTO

- INPUT (MA): H 450±20 - L 100±20
- 12/24 VOLT
- LUMENS (LM): 800
- LED QUANTITY: 13 SMD
- PCB: ALUMINUM SUBSTRATE
- BEAM ANGLE: 360°
- LAMPADA POSIZIONE/STOP A LED

- USAGE: BACK-UP LIGHT, TURNING LIGHT, TAIL LIGHT
- BAY15D - 1157 - P21/5W
- SINGOLO FILAMENTO
- CAN BUS NO ERROR
- LUCE ROSSA POSIZIONE/STOP



ART. 43152



12/24 Volt

SINGOLO FILAMENTO

LUCE FRECCHE  
COLOR ARANCIONE

- INPUT (MA): 450±20
- 12/24 VOLT
- LUMENS (LM): 800
- LED QUANTITY: 13 SMD
- PCB: ALUMINUM SUBSTRATE
- BEAM ANGLE: 360°
- LAMPADA FRECCHE A LED

- USAGE: BACK-UP LIGHT, TURNING LIGHT, TAIL LIGHT
- T20 - 7440 - W21W
- SINGOLO FILAMENTO
- CAN BUS NO ERROR
- LUCE ARANCIONE FRECCHE

ART. 42001

24V

CANBUS

TRUCK

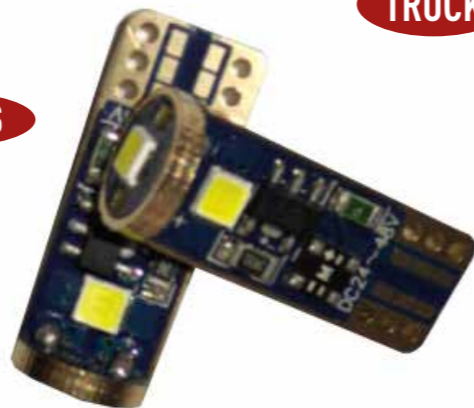

- BASE: T10 W5W (TUTTO VETRO)
- 3 LED SMD "5050"
- LUCE BIANCA FREDDA

- 24 VOLT
- CANBUS

ART. 42260

24V

TRUCK



BA15S - G18,5

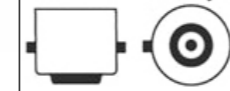

- BASE: BA15S G18,5
- SINGOLO FILAMENTO
- 8 LED

- LUCE BIANCA FREDDA
- 24 VOLT

ART. 42266

24V

T4W

TRUCK



- BASE: BA9S T4W
- PIEDI DRITTI ALLINEATI
- 5 LED SMD "5050"

- LUCE BIANCA FREDDA
- 24 VOLT

ART. 43101

24V

TRUCK



- BASE: T10 W5W (TUTTO VETRO)
- 5 LED SMD "3030"
- LUCE BIANCA FREDDA

- 24 VOLT

ART. 42003

24V

TRUCK



- BASE: T10 W5W (TUTTO VETRO)
- 8 LED SMD
- LUCE BIANCA FREDDA

- 24 VOLT

ART. 42281

24V

TRUCK



- COPPIA RESISTENZE PER SIMULARE UN CARICO DA 5 WATT A 24 VOLT

ART. 42282

24V

TRUCK



- COPPIA RESISTENZE PER SIMULARE UN CARICO DA 21 WATT A 24 VOLT

ART. 42233

24V

41mm

TRUCK



- SILURO T11 C5W
- 41 mm
- 6 LED SMD "5050"

- LUCE BIANCA FREDDA
- 24 VOLT

ART. 42231

24V

36mm

TRUCK



- SILURO T11 C5W
- 36 mm
- 9 LED SMD

- LUCE BIANCA FREDDA
- 24 VOLT

ART. 40259 (24 VOLT)

24V

H7

TRUCK



FILTRO CANCELLER PER  
KIT A LED H7 24 VOLT



ART. 40106

**4000 LUMEN**

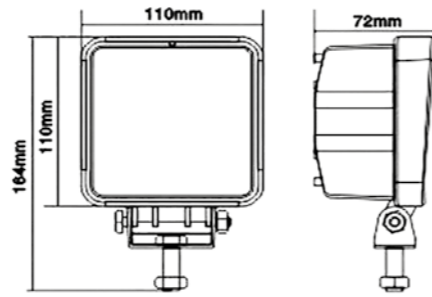

- 16 HIGH POWER LED AD ALTISSIMA LUMINOSITÀ
- ASSORBIMENTO: 48W -3,8A A 12V E 1,9A A 24V
- TENSIONE DI LAVORO: DA 10V A 30V DC
- WATERPROOF RATE: IP 68
- COLORE BIANCO FREDDO: 6000K
- MATERIALE DI COSTRUZIONE: INTERAMENTE IN ALLUMINIO
- COMPLETO DI STAFFE DI FISSAGGIO IN ALLUMINIO
- LUNGHISSIMA DURATA OLTRE 50.000 ORE

ART. 40105

**1500 LUMEN**

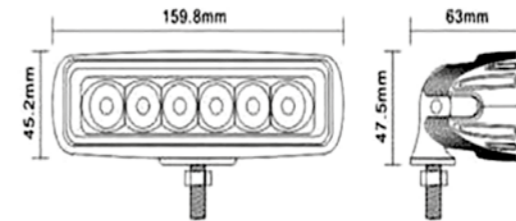

- 6 HIGH POWER LED AD ALTISSIMA LUMINOSITÀ
- ASSORBIMENTO: 18W -1,4A A 12V E 0,7A A 24V
- TENSIONE DI LAVORO: DA 10V A 30V DC
- WATERPROOF RATE: IP 68
- COLORE BIANCO FREDDO: 6000K
- MATERIALE DI COSTRUZIONE: INTERAMENTE IN ALLUMINIO
- COMPLETO DI STAFFE DI FISSAGGIO IN ALLUMINIO
- LUNGHISSIMA DURATA OLTRE 50.000 ORE

ART. 40101

**2300 LUMEN**

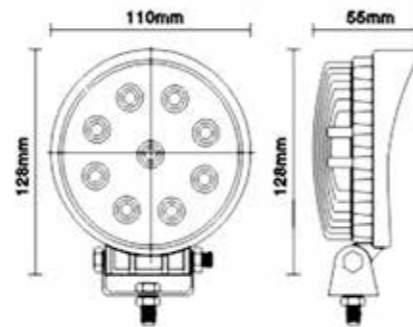

- 9 HIGH POWER LED AD ALTISSIMA LUMINOSITÀ
- ASSORBIMENTO: 27W -2,0A A 12V E 0,9A A 24V
- TENSIONE DI LAVORO: DA 10V A 30V DC
- WATERPROOF RATE: IP 68
- COLORE BIANCO FREDDO: 6000K
- MATERIALE DI COSTRUZIONE: INTERAMENTE IN ALLUMINIO
- COMPLETO DI STAFFE DI FISSAGGIO IN ALLUMINIO
- LUNGHISSIMA DURATA OLTRE 50.000 ORE

ART. 40108

**1620 LUMEN**

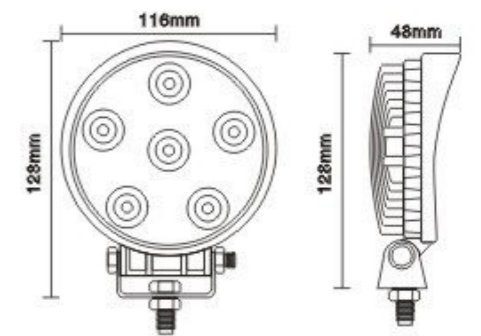

- 6 HIGH POWER LED AD ALTISSIMA LUMINOSITÀ
- ASSORBIMENTO: 1,46A A 12V -0,7A A 24V
- TENSIONE DI LAVORO: DA 10 A 30V DC
- WATERPROOF RATE : IP 67
- COLORE BIANCO FREDDO: 6000K
- MATERIALE DI COSTRUZIONE INTERAMENTE IN ALLUMINIO
- COMPLETO DI STAFFA DI MONTAGGIO IN ACCIAIO
- LUNGHISSIMA DURATA OLTRE 30.000 ORE

ART. 40102

**2300 LUMEN**

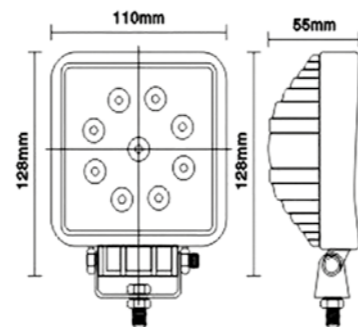

- 9 HIGH POWER LED AD ALTISSIMA LUMINOSITÀ
- ASSORBIMENTO: 27W -2,0A A 12V E 0,9A A 24V
- TENSIONE DI LAVORO: DA 10V A 30V DC
- WATERPROOF RATE: IP 68
- COLORE BIANCO FREDDO: 6000K
- MATERIALE DI COSTRUZIONE: INTERAMENTE IN ALLUMINIO
- COMPLETO DI STAFFE DI FISSAGGIO IN ALLUMINIO
- LUNGHISSIMA DURATA OLTRE 50.000 ORE

ART. 40109

**2160 LUMEN**

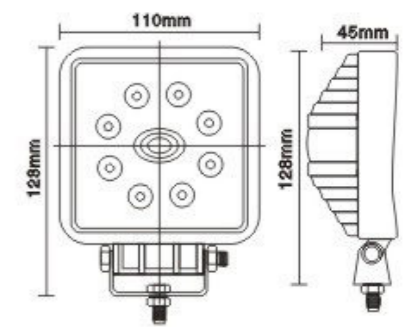

- 8 HIGH POWER LED AD ALTISSIMA LUMINOSITÀ
- ASSORBIMENTO: 1,8A A 12V -0,9A A 24V
- TENSIONE DI LAVORO: DA 10 A 30V DC
- WATERPROOF RATE : IP 67
- COLORE BIANCO FREDDO: 6000K
- MATERIALE DI COSTRUZIONE INTERAMENTE IN ALLUMINIO
- COMPLETO DI STAFFA DI MONTAGGIO IN ACCIAIO
- LUNGHISSIMA DURATA OLTRE 30.000 ORE



ART. 40103

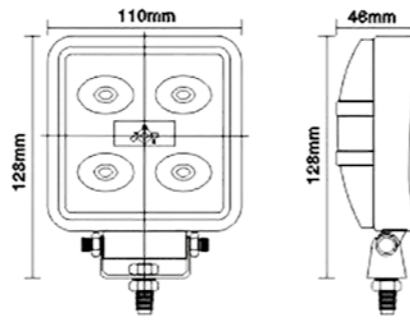

- 5 HIGH POWER LED AD ALTISSIMA LUMINOSITÀ
- ASSORBIMENTO: 15W -1,3A A 12V E 0,65A A 24V
- TENSIONE DI LAVORO: DA 10V A 30V DC
- WATERPROOF RATE: IP 68
- COLORE BIANCO FREDDO: 6000K
- MATERIALE DI COSTRUZIONE: INTERAMENTE IN ALLUMINIO
- COMPLETO DI STAFFE DI FISSAGGIO IN ALLUMINIO
- LUNGHISSIMA DURATA OLTRE 50.000 ORE

**1350 LUMEN**

ART. 40112



- POTENZA TOTALE DEI LED: 30W
- LUMINOSITÀ: 3500 LUMEN
- TENSIONE DI LAVORO: DA 10 A 30V DC
- WATERPROOF: IP 68
- 1 EPISTAR LED DA 30 WATT
- ASSORBIMENTO: 2,6A A 12V-- ,1,21A A 24V
- COLORE BIANCO FREDDO: 6000K
- MATERIALE DI COSTRUZIONE ALLUMINIO
- LENTE IN PMMA
- CORREDATO DI STAFFA DI MONTAGGIO IN ACCIAIO
- FARO DA LAVORO: 160 GRADI
- DURATA VITA FARETTO: 30.000 ORE
- DIMENSIONI: 126 X 126 X 85 MM

**3500 LUMEN**

ART. 40115



- 6 HIGH POWER LED AD ALTISSIMA LUMINOSITÀ
- ASSORBIMENTO: 1,8A A 12V-- ,0,9A A 24V
- TENSIONE DI LAVORO: DA 10 A 30V DC
- WATERPROOF RATE: IP 68
- COLORE BIANCO FREDDO: 6000K
- MATERIALE DI COSTRUZIONE INTERAMENTE IN ALLUMINIO
- COMPLETO DI STAFFA DI MONTAGGIO IN ACCIAIO
- LUNGHISSIMA DURATA OLTRE 30.000 ORE

**2000 LUMEN**

ART. 40113



- POTENZA TOTALE DEI LED: 10W
- LUMINOSITÀ: 1500 LUMEN
- TENSIONE DI LAVORO: DA 10 A 30V DC
- WATERPROOF: IP 68
- 1 CREE LED DA 10 WATT
- ASSORBIMENTO: 1A A 12V-- ,0,5A A 24V
- COLORE BIANCO FREDDO: 6000K
- MATERIALE DI COSTRUZIONE ALLUMINIO
- LENTE IN VETRO
- CORREDATO DI STAFFA DI MONTAGGIO IN ACCIAIO
- DURATA VITA FARETTO: 30.000 ORE
- OMOLOGATI: CE® ROHS® IP68

**1500 LUMEN**

ART. 40104

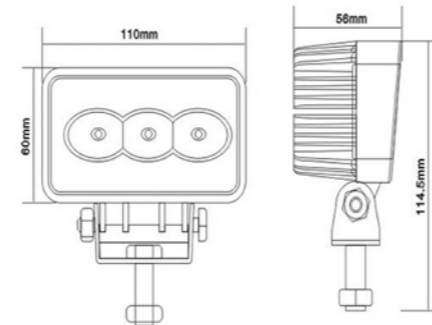

- 3 HIGH POWER LED AD ALTISSIMA LUMINOSITÀ
- ASSORBIMENTO: 9W -0,85A A 12V E 0,42A A 24V
- TENSIONE DI LAVORO: DA 10V A 30V DC
- WATERPROOF RATE: IP 68
- COLORE BIANCO FREDDO: 6000K
- MATERIALE DI COSTRUZIONE: INTERAMENTE IN ALLUMINIO
- COMPLETO DI STAFFE DI FISSAGGIO IN ALLUMINIO
- LUNGHISSIMA DURATA OLTRE 50.000 ORE

**1000 LUMEN**

ART. 40114



- 6 HIGH POWER LED AD ALTISSIMA LUMINOSITÀ
- ASSORBIMENTO: 1,8A A 12V-- ,0,9A A 24V
- TENSIONE DI LAVORO: DA 10 A 30V DC
- WATERPROOF RATE: IP 68
- COLORE BIANCO FREDDO: 6000K
- MATERIALE DI COSTRUZIONE INTERAMENTE IN ALLUMINIO
- COMPLETO DI STAFFA DI MONTAGGIO IN ACCIAIO
- LUNGHISSIMA DURATA OLTRE 30.000 ORE

**2400 LUMEN**



ART. 40121

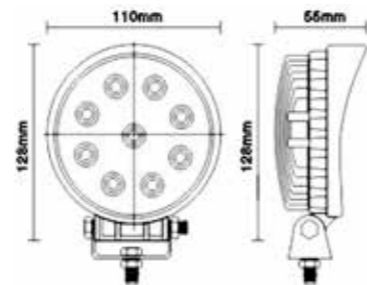

- POTENZA TOTALE DEI LED: 27W
- LUMINOSITÀ: 2300 LUMEN
- TENSIONE DI LAVORO: DA 10 A 30V DC
- WATERPROOF: IP 67
- 9 EPISTAR LED DA 3 WATT CADAUNO
- ASSORBIMENTO: 2A A 12V-- ,0,9A A 24V
- COLORE BIANCO FREDDO: 6000K
- MATERIALE DI COSTRUZIONE ALLUMINIO
- LENTE IN PMMA
- CORREDATO DI STAFFA DI MONTAGGIO IN ACCIAIO
- FARO DI PROFONDITÀ: (30 GRADI)
- DURATA VITA FARETTO: 30.000 ORE

2300  
LUMEN

ART. 40127

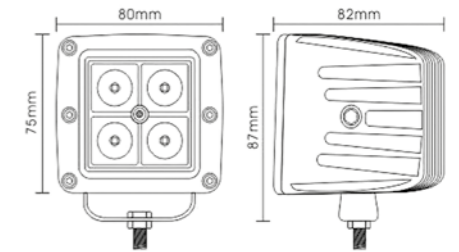

- POTENZA TOTALE DEI LED: 16W
- LUMINOSITÀ: 2100 LUMEN
- TENSIONE DI LAVORO: DA 10 A 30V DC
- WATERPROOF: IP 67
- 4 CREE LED DA 4 WATT CADAUNO
- ASSORBIMENTO: 1.34A A 12V-- ,0.67A A 24V
- COLORE BIANCO FREDDO: 6000K
- MATERIALE DI COSTRUZIONE ALLUMINIO
- LENTE IN PVC
- CORREDATO DI STAFFA DI MONTAGGIO IN ACCIAIO
- FARO DI PROFONDITÀ: (8 GRADI)
- DURATA VITA FARETTO: 30.000 ORE

2100  
LUMEN

ART. 40122

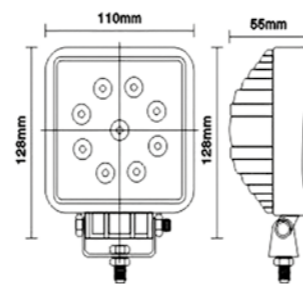

- POTENZA TOTALE DEI LED: 27W
- LUMINOSITÀ: 2300 LUMEN
- TENSIONE DI LAVORO: DA 10 A 30V DC
- WATERPROOF: IP 67
- 9 EPISTAR LED DA 3 WATT CADAUNO
- ASSORBIMENTO: 2A A 12V-- ,0,9A A 24V
- COLORE BIANCO FREDDO: 6000K
- MATERIALE DI COSTRUZIONE ALLUMINIO
- LENTE IN PMMA
- CORREDATO DI STAFFA DI MONTAGGIO IN ACCIAIO
- FARO DI PROFONDITÀ: (30 GRADI)
- DURATA VITA FARETTO: 30.000 ORE

2300  
LUMEN

ART. 40120



- POTENZA TOTALE DEI LED: 10W
- LUMINOSITÀ: 1500 LUMEN
- TENSIONE DI LAVORO: DA 10 A 30V DC
- WATERPROOF: IP 67
- 1 CREE LED DA 10 WATT
- ASSORBIMENTO: 1A A 12V-- ,0,5A A 24V
- COLORE BIANCO FREDDO: 6000K
- MATERIALE DI COSTRUZIONE ALLUMINIO
- LENTE IN PVC
- CORREDATO DI STAFFA DI MONTAGGIO IN ACCIAIO
- FARO DI PROFONDITÀ: (8 GRADI)
- DURATA VITA FARETTO: 30.000 ORE

1500  
LUMEN

ART. 40125

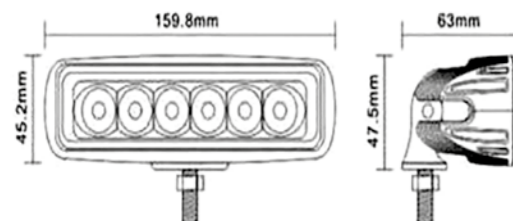

- POTENZA TOTALE DEI LED: 18W
- LUMINOSITÀ: 1500 LUMEN
- TENSIONE DI LAVORO: DA 10 A 30V DC
- WATERPROOF: IP 67
- 6 EPISTAR LED DA 3 WATT CADAUNO
- ASSORBIMENTO: 1.4A A 12V-- ,0.7A A 24V
- COLORE BIANCO FREDDO: 6000K
- MATERIALE DI COSTRUZIONE ALLUMINIO
- LENTE IN PVC
- CORREDATO DI STAFFA DI MONTAGGIO IN ACCIAIO
- FARO DI PROFONDITÀ: (25 GRADI)
- DURATA VITA FARETTO: 30.000 ORE

1500  
LUMEN

ART. 40123



- POTENZA TOTALE DEI LED: 10W
- LUMINOSITÀ: 1500 LUMEN
- TENSIONE DI LAVORO: DA 10 A 30V DC
- WATERPROOF: IP 68
- 1 CREE LED DA 10 WATT
- ASSORBIMENTO: 1A A 12V-- ,0,5A A 24V
- COLORE BIANCO FREDDO: 6000K
- MATERIALE DI COSTRUZIONE ALLUMINIO
- LENTE IN VETRO
- CORREDATO DI STAFFA DI MONTAGGIO IN ACCIAIO
- FARO DI PROFONDITÀ: 8 GRADI
- DURATA VITA FARETTO: 30.000 ORE
- OMOLOGATI: CE® ROHS® IP68

1500  
LUMEN



ART. 40950

**12  
LED**



- POTENZA TOTALE DEI LED: 36W
- MISURE: 20 x 8 x 9 cm (lung. x larg. x prof.)
- LUMINOSITÀ: 2800 LUMEN
- TENSIONE DI LAVORO: DA 10 A 30V DC
- 6000K
- PESO: 1 KG
- WATERPROOF : IP 67
- MATERIALE DI COSTRUZIONE ALLUMINIO
- CORREDATO DI STAFFA DI MONTAGGIO IN ACCIAIO

ART. 40951

**24  
LED**



- POTENZA TOTALE DEI LED: 72W
- MISURE: 36 x 8 x 9 cm (lung. x larg. x prof.)
- LUMINOSITÀ: 5600 LUMEN
- TENSIONE DI LAVORO: DA 10 A 30V DC
- 6000K
- PESO: 3 KG
- WATERPROOF : IP 67
- MATERIALE DI COSTRUZIONE ALLUMINIO
- CORREDATO DI STAFFA DI MONTAGGIO IN ACCIAIO

ART. 40952

**40  
LED**



- POTENZA TOTALE DEI LED: 120W
- MISURE: 56 x 8 x 9 cm (lung. x larg. x prof.)
- LUMINOSITÀ: 9200 LUMEN
- TENSIONE DI LAVORO: DA 10 A 30V DC
- 6000K
- PESO: 4 KG
- WATERPROOF : IP 67
- MATERIALE DI COSTRUZIONE ALLUMINIO
- CORREDATO DI STAFFA DI MONTAGGIO IN ACCIAIO

ART. 40955

**108  
LED**



- POTENZA TOTALE DEI LED: 300W
- MISURE: 132 x 8 x 9 cm (lung. x larg. x prof.)
- LUMINOSITÀ: 25000 LUMEN
- TENSIONE DI LAVORO: DA 10 A 30V DC
- 6000K
- PESO: 8 KG
- WATERPROOF : IP 67
- MATERIALE DI COSTRUZIONE ALLUMINIO
- CORREDATO DI STAFFA DI MONTAGGIO IN ACCIAIO

ART. 40953

**60  
LED**



- POTENZA TOTALE DEI LED: 180W
- MISURE: 81 x 8 x 9 cm (lung. x larg. x prof.)
- LUMINOSITÀ: 14000 LUMEN
- TENSIONE DI LAVORO: DA 10 A 30V DC
- 6000K
- PESO: 5,3 KG
- WATERPROOF : IP 67
- MATERIALE DI COSTRUZIONE ALLUMINIO
- CORREDATO DI STAFFA DI MONTAGGIO IN ACCIAIO

ART. 40954

**80  
LED**



- POTENZA TOTALE DEI LED: 240W
- MISURE: 107 x 8 x 9 cm (lung. x larg. x prof.)
- LUMINOSITÀ: 18000 LUMEN
- TENSIONE DI LAVORO: DA 10 A 30V DC
- 6000K
- PESO: 6,5 KG
- WATERPROOF : IP 67
- MATERIALE DI COSTRUZIONE ALLUMINIO
- CORREDATO DI STAFFA DI MONTAGGIO IN ACCIAIO



**ART. 40000 - 12V**

**ART. 40020 - 24V**

- LUNGHEZZA 30 CM
- ALTEZZA 3,3 CM
- SPESSORE MAX 0,9 CM
- 42 LED
- 12 o 24 V - 4 W

30 CM

**BIANCO FREDDO**  
**6000K**

**UTILIZZO SU CAMPER, ROULOTTE, FURGONI,  
AUTO, ALLESTIMENTI VARI**

**ART. 40001 - 12V**

**ART. 40021 - 24V**

- LUNGHEZZA 50 CM
- ALTEZZA 3,3 CM
- SPESSORE MAX 0,9 CM
- 56 LED
- 12 o 24 V - 6 W

50 CM

100 CM

**ART. 40002 - 12V**

**ART. 40022 - 24V**

- LUNGHEZZA 100 CM
- ALTEZZA 3,3 CM
- SPESSORE MAX 0,9 CM
- 112 LED
- 12 o 24 V - 12 W

**WATERPROOF IP65**

IN DOTAZIONE CON OGNI BARRA



**COMPONIBILI TRA LORO**  
GIUNZIONE PER PLAFONIERE

**ART. 40007**



**ORIENTABILI 90°**

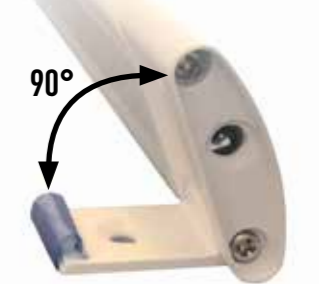

**ACCESSORI**

**ART. 40005**



- CONNETTORE (MORSETTIERA) ALIMENTAZIONE PLAFONIERE

**ART. 40009**



- INTERRUTTORE PER PLAFONIERE

**ACCESSORI**

**ART. 40006**



- INTERRUTTORE TOUCH PER PLAFONIERE

**ART. 40008**



- SENSORE DI PRESENZA PIR PER PLAFONIERE
- ORIENTABILE 90°
- TEMPO-REGOLABILE



ART. 70101



- INPUT 220 VOLT
- OUTPUT 12 VOLT
- POWER 12 WATT / 1A
- WATERPROOF IP67
- WORKING TEMPERATURE: -20°C - +70°C
- HIGH EFFICIENCY, LONG LIFE AND HIGH RELIABILITY
- WITHSTAND 5G VIBRATION TEST
- LED INDICATOR FOR POWER ON
- 100% FULL LOAD BURN-IN TEST
- UNIVERSAL AC INPUT / FULL RANGE

**12W**  
**1A**

ART. 70102



- INPUT 220 VOLT
- OUTPUT 12 VOLT
- POWER 25,2 WATT / 2,1A
- WORKING TEMPERATURE: -20°C - +70°C
- HIGH EFFICIENCY, LONG LIFE AND HIGH RELIABILITY
- WITHSTAND 5G VIBRATION TEST
- LED INDICATOR FOR POWER ON
- 100% FULL LOAD BURN-IN TEST
- UNIVERSAL AC INPUT / FULL RANGE

**25,2W**  
**2,1A**

ART. 70103



- INPUT 220 VOLT
- OUTPUT 12 VOLT
- POWER 50 WATT / 4,2A
- WORKING TEMPERATURE: -20°C - +70°C
- HIGH EFFICIENCY, LONG LIFE AND HIGH RELIABILITY
- WITHSTAND 5G VIBRATION TEST
- LED INDICATOR FOR POWER ON
- 100% FULL LOAD BURN-IN TEST
- UNIVERSAL AC INPUT / FULL RANGE

**50W**  
**4,2A**

ART. 70104



- INPUT 220 VOLT
- OUTPUT 12 VOLT
- POWER 75 WATT / 6A
- WORKING TEMPERATURE: -20°C - +70°C
- HIGH EFFICIENCY, LONG LIFE AND HIGH RELIABILITY
- WITHSTAND 5G VIBRATION TEST
- LED INDICATOR FOR POWER ON
- 100% FULL LOAD BURN-IN TEST
- UNIVERSAL AC INPUT / FULL RANGE

**75W**  
**6A**

ART. 70105



- INPUT 220 VOLT
- OUTPUT 12 VOLT
- POWER 100 WATT / 8,5A
- WORKING TEMPERATURE: -20°C - +70°C
- HIGH EFFICIENCY, LONG LIFE AND HIGH RELIABILITY
- WITHSTAND 5G VIBRATION TEST
- LED INDICATOR FOR POWER ON
- 100% FULL LOAD BURN-IN TEST
- UNIVERSAL AC INPUT / FULL RANGE

**100W**  
**8,5A**

ART. 70106



- INPUT 220 VOLT
- OUTPUT 12 VOLT
- POWER 150 WATT / 12,5A
- WORKING TEMPERATURE: -20°C - +70°C
- HIGH EFFICIENCY, LONG LIFE AND HIGH RELIABILITY
- WITHSTAND 5G VIBRATION TEST
- LED INDICATOR FOR POWER ON
- 100% FULL LOAD BURN-IN TEST
- UNIVERSAL AC INPUT / FULL RANGE

**150W**  
**12,5A**

ART. 70107



- INPUT 220 VOLT
- OUTPUT 12 VOLT
- POWER 240 WATT / 20A
- WORKING TEMPERATURE: -20°C - +70°C
- HIGH EFFICIENCY, LONG LIFE AND HIGH RELIABILITY
- WITHSTAND 5G VIBRATION TEST
- LED INDICATOR FOR POWER ON
- 100% FULL LOAD BURN-IN TEST
- UNIVERSAL AC INPUT / FULL RANGE

**240W**  
**20A**



ROLL.5050WW (sfondo bianco - luce bianca) - ROLL.5050WB (sfondo bianco - luce blu)



- 300 LED 5050 • 3 CHIP SU 5 METRI • SFONDO BIANCO • ALTISSIMA LUMINOSITA' • BOBINA A LED LUNGA 5 METRI • UTILIZZO: DECORO AUTO, ILLUMINAZIONI AUTO, CASA, CAMPER, TUNING
- IMPERMEABILE IP 67 • ILLUMINAZIONE: BIANCO GHIACCIO 6000K (COME GLI XENON) • TAGLIABILE OGNI 3 LED • COMPLETE DI BIADESIVO RESISTENTE ALL'ACQUA • LUNGA DURATA
- BASSISSIMO CONSUMO • 12 VOLT

ROLL.5050BR (sfondo nero - luce rossa) - ROLL.5050BB (sfondo nero - luce blu) - ROLL.5050BW (sfondo nero - luce bianca fredda)



- 300 LED 5050 • 3 CHIP SU 5 METRI • SFONDO NERO • ALTISSIMA LUMINOSITA' • BOBINA A LED LUNGA 5 METRI • UTILIZZO: DECORO AUTO, ILLUMINAZIONI AUTO, CASA, CAMPER, TUNING
- IMPERMEABILE IP 67 • ILLUMINAZIONE: BIANCO GHIACCIO 6000K (COME GLI XENON), NERO, ROSSO • TAGLIABILE OGNI 3 LED • COMPLETE DI BIADESIVO RESISTENTE ALL'ACQUA • LUNGA DURATA • BASSISSIMO CONSUMO • 12 VOLT

ROLL.LTW (luce bianca fredda)



- 300 LED LATERALI SU 5 METRI • SFONDO NERO • BOBINA A LED LUNGA 5 METRI • UTILIZZO: DECORO AUTO, ILLUMINAZIONI AUTO, CASA, CAMPER, TUNING
- IMPERMEABILE IP 67 • ILLUMINAZIONE: BIANCO GHIACCIO 6000K (COME GLI XENON), ROSSA • TAGLIABILE OGNI 3 LED • COMPLETE DI BIADESIVO RESISTENTE ALL'ACQUA • LUNGA DURATA • BASSISSIMO CONSUMO • 12 VOLT

ROLL.RGB (300 LED)



- 300 LED RGB SU 5 METRI • SFONDO TRASPARENTE • BOBINA A LED LUNGA 5 METRI • UTILIZZO: DECORO AUTO, ILLUMINAZIONI AUTO, CASA, CAMPER, TUNING
- IMPERMEABILE IP 67 • ILLUMINAZIONE: FULL RGB • TAGLIABILE OGNI 3 LED • COMPLETE DI BIADESIVO RESISTENTE ALL'ACQUA • LUNGA DURATA • BASSISSIMO CONSUMO • 12 VOLT

ROLL.24V W (luce bianca fredda) - ROLL.24V B (luce blu) - ROLL.24V R (luce rossa) - ROLL.24V RGB



- 300 LED "3528" SU 5 METRI • BOBINA DA 5 METRI • SFONDO NERO • BOBINA A LED LUNGA 5 METRI • UTILIZZO: DECORO CAMION, CAMION TUNING
- IMPERMEABILE IP 67 • ILLUMINAZIONE: BIANCO GHIACCIO 6000K (COME GLI XENON), NERO, ROSSO, VERDE, ARANCIO • TAGLIABILE OGNI 3 LED • COMPLETE DI BIADESIVO RESISTENTE ALL'ACQUA • LUNGA DURATA • BASSISSIMO CONSUMO • 24 VOLT

TC.RGB

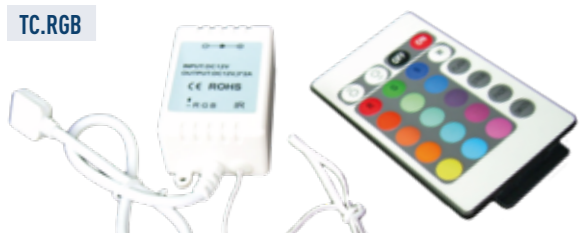

- TELECOMANDO PER BOBINE RGB 12 VOLT

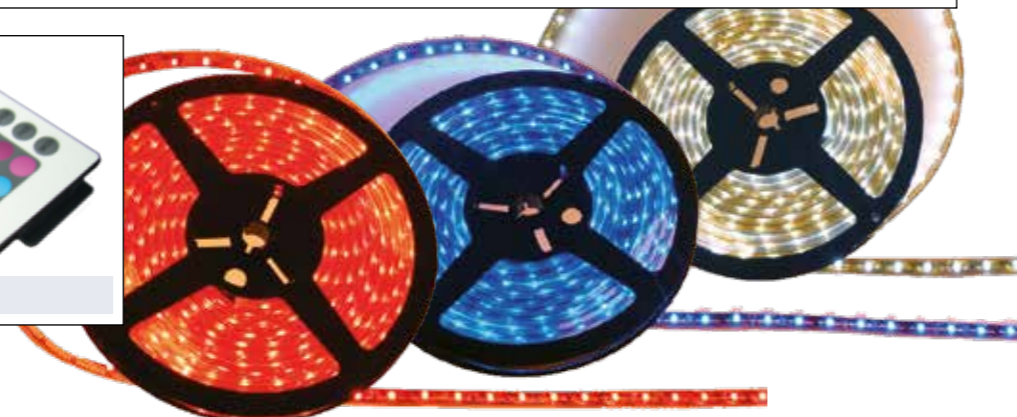

# XENON LINE

QUALITA' E CONVENIENZA. EXTRA SLIM PER MINOR INGOMBRO.



## TUTTI I KIT SONO COMPOSTI DA 2 BALLAST E 2 LAMPADINE

AD ESCLUSIONE DEI KIT MOTO

### 12 VOLT STANDARD LINE

- ART. 45117 KIT XENON HB4 6000K 12 VOLT
- ART. 45114 KIT XENON HB3 6000K 12 VOLT
- ART. 45136 KIT XENON H9 6000K 12 VOLT
- ART. 45135 KIT XENON H7 SCHERMATA 6000K 12 VOLT
- ART. 45134 KIT XENON H7 6000K CORTA 12 VOLT
- ART. 45133 KIT XENON H7 8000K 12 VOLT
- ART. 45132 KIT XENON H7 5000 K 12 VOLT
- ART. 45112 KIT XENON H7 12 VOLT 6000K
- ART. 45111 KIT BIXENON H4 6000K 12 VOLT
- ART. 45119 KIT XENON H3 6000K 12 VOLT
- ART. 45123 KIT BIXENON H13 6000K 12 VOLT
- ART. 45113 KIT XENON H11 6000K 12 VOLT
- ART. 45116 KIT XENON H1 6000K 12 VOLT
- ART. 45122 KIT XENON D2S 6000K 12 VOLT

### 12 VOLT MOTORCYCLES LINE

- ART. 45182 KIT XENON MOTO H7 6000K 12 VOLT (1 ballast slim, 1 lamp. H7)
- ART. 45181 KIT BIXENON MOTO H4 6000K 12 VOLT (1 ballast slim, 1 lamp. H4BX)
- SET.MOTOTMAX KIT XENON SPECIFICO PER MOTO TMAX H7 METAL BASE E H4 BIXENON 6000K, 12 VOLT (2 ballast slim, 1 lamp. H4BX, 1 lamp H7M)

### 24 VOLT STANDARD LINE

- ART. 45152 KIT XENON H7 6000K 24 VOLT
- ART. 45151 KIT BIXENON H4 6000K 24 VOLT
- ART. 45153 KIT XENON H11 6000K 24 VOLT
- ART. 45156 KIT XENON H1 6000K 24 VOLT

TUTTI I KIT POSSONO ESSERE RICHIESTI CON QUALSIASI MODELLO DI LAMPADINA XENON, ANCHE SE NON PRESENTE NELLA LISTA DEI KIT ELENCATI.





## GOLD LINE

TUTTI I PRODOTTI HS GROUP CHIAMATI GOLD RAPPRESENTANO UNA LINEA DI PRODOTTI D'ELITE, UNA SCELTA NELLA TECNOLOGIA AVANZATA, AFFIDABILITÀ E DI ESTETICA.

I KIT GOLD SONO PRODOTTI SU NOSTRA RICHIESTA ESCLUSIVA E BREVETTO.

I KIT XENON GOLD SONO TESTATI UNO AD UNO, OGNI BALLAST RIPORTA IL NUMERO DI SERIE INCISO CON IL QUALE SI PUÒ IDENTIFICARE IL LOTTO DI PRODUZIONE E L'OPERATORE CHE L'HA TESTATO.

I KIT GOLD RISOLVONO TUTTE LE PROBLEMATICHE SULLE AUTO DI NUOVISSIMA GENERAZIONE, FORD, RENAULT, OPEL, HYUNDAI, VOLKSWAGEN, AUDI ETC. SENZA AGGIUNGERE ALCUN MODULO, FILTRO O RESISTENZA.

### TUTTI I KIT GOLD SONO COMPOSTI DA 2 BALLAST E 2 LAMPADINE

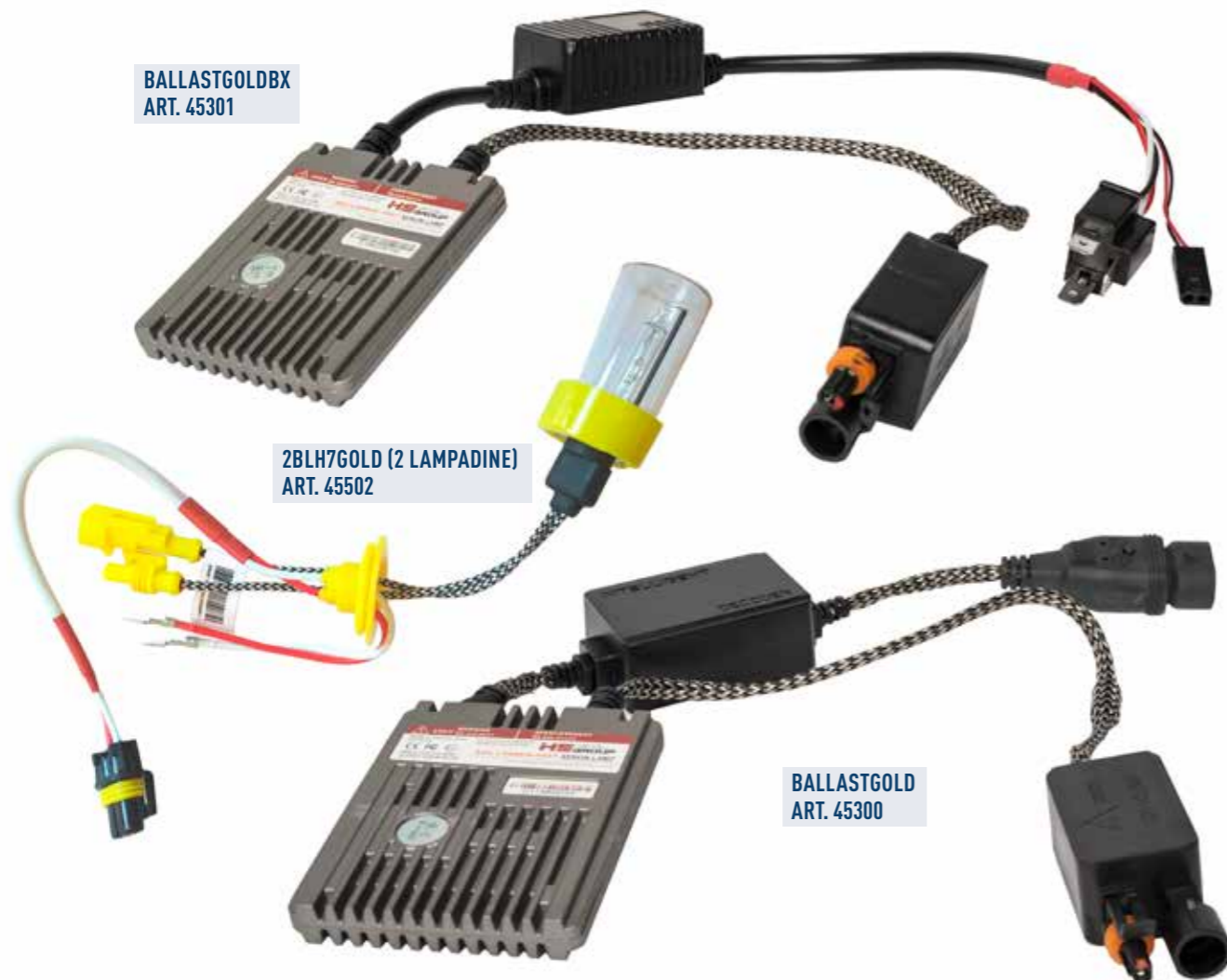

## GOLD LINE

IL KIT GOLD NON SOSTITUISCE LE ALTRE NOSTRE LINEE DI PRODOTTO (STANDARD, PRO) È SEMPLICEMENTE UN PRODOTTO GOLD QUINDI TOP DI GAMMA.

### GOLD LINE

• ART. 45312	• SET.GOLDH7	H7 5700K
• ART. 45313	• SET.GOLDH11	H11 5700K
• ART. 45326	• SET.GOLDH8	H8 5700K
• ART. 45314	• SET.GOLDHB3	HB3/9005 5700K
• ART. 45327	• SET.GOLDHIR2	HIR2/9012 5700K
• ART. 45311	• SET.GOLDH4BX	H4 BIXENON 5700K
• ART. 45300	• BALLASTGOLD	BALLAST RICAMBIO
• ART. 45301	• BALLASTGOLDBX	BALLAST BIXENON RICAMBIO
• ART. 45502	• 2BLH7GOLD	2 LAMPADINE H7 GOLD RICAMBIO
• ART. 45616	• 2BLH11GOLD	2 LAMPADINE H11 GOLD RICAMBIO
• ART. 45503	• 2BLH8GOLD	2 LAMPADINE H8 GOLD RICAMBIO
• ART. 45504	• 2BLHB3GOLD	2 LAMPADINE HB3/9005 GOLD RICAMBIO
• ART. 45505	• 2BLHIR2GOLD	2 LAMPADINE HIR2/9012 GOLD RICAMBIO
• ART. 45501	• 2BLH4BXGOLD	2 LAMPADINE H4 BIXENON GOLD RICAMBIO





## PRO LINE

RISOLVE TUTTE LE PROBLEMATICHE ANCHE SU AUTO PARTICOLARMENTE DIFFICOLTOSE:  
AUDI, MERCEDES, GRUPPO VW, BMW E TUTTE LE AUTO DI NUOVA GENERAZIONE.  
CON IL KIT PRO LE CENTRALINE ELETTRONICHE DI TUTTE LE AUTO  
NON SUBISCONO ALCUN DANNO. QUALITA' ESTREMA E DURATA NEL TEMPO.

### 12 VOLT PRO LINE

- ART. 45216 KIT XENON PROFESSIONALE CAN BUS H1 6000K 12 VOLT
- ART. 45213 KIT XENON PROFESSIONALE CAN BUS H11 6000K 12 VOLT
- ART. 45221 KIT XENON PROFESSIONALE CAN BUS H27 6000K 12 VOLT
- ART. 45211 KIT BIXENON PROFESSIONALE CAN BUS H4 6000K 12 VOLT
- ART. 45212 KIT XENON CAN BUS PROFESSIONALE H7 6000K 12 VOLT
- ART. 45232 KIT XENON PROFESSIONALE CAN BUS H7 5000K 12 VOLT
- ART. 45233 KIT XENON PROFESSIONALE CAN BUS H7 8000K 12 VOLT
- ART. 45234 KIT XENON CAN BUS PROFESSIONALE H7 CORTA 6000K 12 VOLT METAL BASE, CONSIGLIATO PER AUTO CON FARI PARABOLA OTTURATORE, PER EVITARE CHE LA LAMPADINA TOCCHI. QUESTO KIT E' INSISPENSABILE SU AUDI A3 (PER EVITARE DANNI)
- ART. 45235 KIT XENON PROFESSIONALE CAN BUS H7R SCHERMATA 6000K 12 VOLT
- ART. 45236 KIT XENON CAN BUS PROFESSIONALE H9 6000K 12 VOLT
- ART. 45217 KIT XENON PROFESSIONALE CAN BUS HB4 6000K 12 VOLT
- ART. 45238 KIT BIXENON CAN BUS PROFESSIONALE HB5 6000K 12 VOLT
- SET.PROMOTOH4BX KIT BIXENON MOTO PROFESSIONALE H4 6000K 12 VOLT CAN BUS
- ART. 45253 KIT XENON MOTO CAN BUS PROFESSIONALE H7 6000K 12 VOLT
- SET.PROTMAX KIT XENON SPECIFICO PER MOTO TMAX H7 METAL BASE E H4 BIXENON 6000K, 12 VOLT (2 ballast PRO, 1 lamp. H4BX, 1 lamp H7M) + ADATTATORE



## TUTTI I KIT SONO COMPOSTI DA 2 BALLAST E 2 LAMPADINE

AD ESCLUSIONE DEI KIT MOTO







**ART. 45633**

- LAMPADA HID XENON H7 6000K BASE IN METALLO



**ART. 45636**

- LAMPADA HID XENON H7 6000K BASE IN METALLO 50 WATT



**ART. 45635**

- LAMPADA HID XENON H7 5000K BASE IN METALLO

**ART. 45634**

- LAMPADA HID XENON H7 4300K BASE IN METALLO



**ART. 45637**

- LAMPADA HID XENON H7 8000K BASE IN METALLO



**ART. 45640**

- LAMPADA HID XENON H7R 6000K BASE IN METALLO

**ART. 45641**

- LAMPADA HID XENON H7R 5000K BASE IN METALLO



**ART. 45638**

- LAMPADA HID XENON H7 EXTRA CORTA 6000K BASE IN METALLO

**ART. 45639**

- LAMPADA HID XENON H7 EXTRA CORTA 5000K BASE IN METALLO



**ART. 45612**

- LAMPADA HID XENON H1 6000K

**ART. 45621**

- LAMPADA HID XENON H1 8000K

**ART. 45619**

- LAMPADA HID XENON H1 5000K



**ART. 45643**

- LAMPADA HID XENON H9 6000K



**ART. 45614**

- LAMPADA HID XENON H11 6000K

**ART. 45615**

- LAMPADA HID XENON H11 5000K

**ART. 45613**

- LAMPADA HID XENON H10 6000K

**ART. 45622**

- LAMPADA HID XENON H27 - 880 - 881 - 6000K



**ART. 45628**

- LAMPADA HID H4 BIXENON 6000K (BASE RIMOVIBILE)

**ART. 45630**

- LAMPADA HID H4 BIXENON 5000K (BASE RIMOVIBILE)

**ART. 45629**

- LAMPADA HID H4 BIXENON 4300K (BASE RIMOVIBILE)

**ART. 45631**

- LAMPADA HID H4 BIXENON 8000K (BASE RIMOVIBILE)



**ART. 45627**

- LAMPADA HID XENON H4 6000K (anabbagliante xenon, abbagliante alogeno)



**ART. 45632**

- LAMPADA HID H4 SINGOLA 6000K



**ART. 45644**

- LAMPADA HID XENON HB3 9005 6000K



**ART. 45645**

- LAMPADA HID XENON HB3 9005 5000K



**ART. 45618**

- LAMPADA HID H13 BIXENON 6000K



**ART. 45646**

- LAMPADA HID XENON HB4 9006 6000K



**ART. 45647**

- LAMPADA HID HB5 9007 6000K

**ART. 45648**

- LAMPADA HID HB5 9007 BIXENON 6000K



**ART. 45642**

- LAMPADA HID XENON HB8 6000K



**ART. 45623**

- LAMPADA HID XENON H3 6000K

**ART. 45624**

- LAMPADA HID XENON H3 5000K

**ART. 45625**

- LAMPADA HID XENON H3 8000K



**ART. 45611**

- LAMPADA HID XENON D4S - D4C 6000K



**ART. 45609**

- LAMPADA HID XENON D3S 6000K

**ART. 45610**

- LAMPADA HID XENON D3S 6000K

**ART. 45608**

- LAMPADA HID XENON D3C 6000K



**ART. 45602**

- LAMPADA HID XENON D1S 6000K

**ART. 45603**

- LAMPADA HID XENON D1S 4300K



**ART. 45601**

- LAMPADA HID XENON D1R 6000K



**ART. 45606**

- LAMPADA HID XENON D2R 6000K



**ART. 45604**

- LAMPADA HID XENON D2C 6000K

**ART. 45605**

- LAMPADA HID XENON D2H 6000K



**ART. 45607**

- LAMPADA HID XENON D2S 6000K





**ART. 47761**

- CONDENSATORI/STABILIZZATORI DI CORRENTE A 12 VOLT
- PER RISOLVERE I PROBLEMI NEGLI XENON DI SPIA ACCESA, SFARFALLO DELLE LUCI, SPEGNIMENTO DI UN FARO, ECC.
- 12 VOLT - 1 COPPIA

**ART. 47762**

- CONDENSATORI/STABILIZZATORI DI CORRENTE A 24 VOLT
- PER RISOLVERE I PROBLEMI NEGLI XENON DI SPIA ACCESA, SFARFALLO DELLE LUCI, SPEGNIMENTO DI UN FARO, ECC.
- 24 VOLT - 1 COPPIA



**ART. 47756**

- CABLAGGIO INDIPENDENTE PER SINGOLA LAMPADA H4-3 BIXENON.
- RICONOSCE AUTOMATICAMENTE LA POLARITA', INDISPENSABILE PER LE AUTO JAPPONESI CON POLARITA' INVERTITA'. CONSIGLIATO PER TUTTE LE AUTO CON H4 BIXENON PER SEMPLIFICARE
- L'INSTALLAZIONE. GIA' IN DOTAZIONE SUL SET. PRO H4.
- 12 VOLT - 1 COPPIA



**ART. 47755**

- CABLAGGIO INDIPENDENTE PER SINGOLA LAMPADA H4-3 BIXENON.
- CONSIGLIATO PER TUTTE LE AUTO CON H4 BIXENON PER SEMPLIFICARE
- L'INSTALLAZIONE. GIA' IN DOTAZIONE SUL NOSTRO SET.H4 STANDARD
- 12VOLT - 1 COPPIA



**ART. 47760**

- RESISTENZA CORRAZZATA PER KIT XENON, PORTA L'ASSORBIMENTO
- DEGLI XENON DA 35W A 55W PER ILLUDERE IL COMPUTER DI BORDO
- 12 VOLT - 1 COPPIA



**ART. 45753**

- CENTRALINA TRADIZIONALE CON CABLAGGIO PER XENON H4 BIXENON 12 VOLT

**ART. 45754**

- CENTRALINA TRADIZIONALE CON CABLAGGIO PER XENON H4 BIXENON 24 VOLT



**ART. 45750**

- PORTALAMPADA XENON PER D2S - D2R -2DC



**ART. 45730**

- CONVERTITORE ATTACCHI LAMPADA XENON AMP-KET



**ART. 45727**

- PORTALAMPADA XENON ORIGINALE D1S - D2S - D3S - D4S
- 1 COPPIA



**ART. 45711**

- PROLUNGA PER LAMPADA XENON DA 1 METRO



**AD.128**

- PORTALAMPADA XENON - MODIFICA
- CONVERTE DA D2S A H7.H1 O ALTRI MODELLI DI LAMPADE
- 1 COPPIA



**AD.132**

- Cablaggio con relè per kit xenon



**ART. 45751**

- FILTRO
- VOLKSWAGEN, AUDI, SEAT, MERCEDES, SKODA 2011/2012



**ART. 45700**

- PORTALAMPADA XENON H7 PER BMW E39
- (2 MODELLO) 1 COPPIA



**ART. 45707**

- PORTALAMPADA XENON IN METALLO H7 PER
- BMW X5, AUDI, VW PASSAT, OPEL VECTRA C, OPEL ASTRA H, SAAB 93, FORD FIESTA, NISSAN QASHQAI, ALCUNE MERCEDES ECC...
- ALFA MITO (CON PICCOLA MODIFICA) 1 COPPIA



**ART. 45701**

- PORTALAMPADA XENON H7 PER BMW E39
- (1 MODELLO) 1 COPPIA





**ART. 45716**

- PORTALAMPADA XENON H7 PER MERCEDES BENZ, AUDI, BMW X5
- 1 COPPIA





**ART. 45715**

- PORTALAMPADA XENON H7 PER VW PASSAT, OPEL VECTRA C, SAAB 93, AUDI, BMW X5
- 1 COPPIA

**ART. 45702**

- PORTALAMPADA XENON H7 PER BMW E39 (3MODELLO 1996-2003)
- 1 COPPIA





**ART. 45704**

- PORTALAMPADA XENON H7 PER BMW E46 (MODELLO NERO) 1 COPPIA

**ART. 45703**

- PORTALAMPADA XENON H7 PER BMW E46 (MODELLO BIANCO)
- 1 COPPIA



**ART. 45726**

- PORTALAMPADA XENON D2S PER BMW E46 SERIE 3.
- CONVERTE DA H7 A D2S
- 1 COPPIA



**ART. 45729**

- ADATTATORE LAMPADA XENON H7
- CITROEN C5, PEUGEOT 508,3008, RENAULT CLIO SPORTOUR(2011)



**ART. 45725**

- PORTALAMPADA XENON H7 PER FIAT NUOVA 500
- 1 COPPIA





**ART. 45718**



- PORTALAMPADA XENON H7 PER FORD FOCUS "ANABBAGLIANTE"
- 1 COPPIA

**ART. 45719**



- PORTALAMPADA XENON H7/H1 PER FORD MONDEO "ABBAGLIANTE"
- 1 COPPIA

**ART. 45736**



- ADATTATORE/PORTALAMPADA H7 PER ANABBAGLIANTE
- KIA RIO, CARENS
- HYUNDAI ELANTRA

**ART. 45712**



- PORTALAMPADA XENON H1 PER MERCEDES BENZ 320
- 1 COPPIA

**ART. 45722**



- PORTALAMPADA XENON H7 PER FORD MAVERICK
- 1 COPPIA

**ART. 45710**



- PORTALAMPADA XENON H7/H1 PER FORD MONDEO "ANABBAGLIANTE"
- 1 COPPIA

**ART. 45734**



- ADATTATORE/PORTALAMPADA H7
- VW GOLF VII, SCIROCCO 2012, TOURAN 2011
- SEAT ALAMBRA 2012
- MERCEDES SPRINTER 2014

**ART. 45713**



- PORTALAMPADA XENON H7 PER OPEL
- 1 COPPIA

**ART. 45733**



- ADATTATORE/PORTALAMPADA H7
- LAND ROVER FREELANDER 2, FORD FOCUS E MONDEO CHIA-X

**ART. 45706**



- PORTALAMPADA XENON H1
- FORD FOCUS "ABBAGLIANTE"
- 1 COPPIA

**ART. 45714**



- PORTALAMPADA XENON H7 PER OPEL, HONDA CRV, MAZDA 3, ECC
- 1 COPPIA

**ART. 45720**



- PORTALAMPADA XENON H7 PER VW NEW BORA E BUICK NEW REAL
- 1 COPPIA

**ART. 45731**



- ADATTATORE/PORTALAMPADA H7
- HYUNDAI SANTA FE

**ART. 45724**



- PORTALAMPADA XENON H1 PER HONDA ODYSSEY CON 4 ALETTE VECCHIO MODELLO - 1 COPPIA

**ART. 45708**



- PORTALAMPADA XENON H7 PER VW GOLF V
- 1 COPPIA

**ART. 45737**



- ADATTATORE/PORTALAMPADA H7 PER ANABBAGLIANTE HYUNDAI TUCSON

**ART. 45717**



- PORTALAMPADA XENON H7 PER HYUNDAI
- 1 COPPIA

**ART. 45723**



- PORTALAMPADA XENON H1 PER HONDA ODYSSEY CON 2 ALETTE NUOVO MODELLO - 1 COPPIA

**ART. 45709**



- PORTALAMPADA XENON H7 PER GOLF VI
- 1 COPPIA

**ART. 45735**



- PORTALAMPADA XENON H7 PER HYUNDAI
- 1 COPPIA

**ART. 45705**



- PORTALAMPADA XENON D2C PER MERCEDES 1 COPPIA

**ART. 45721**



- PORTALAMPADA XENON H7 PER VW TOURAN, CADDY, JETTA...
- 1 COPPIA





# H.O.D.®

High Definition Olive Lamp (H.O.D)

H.O.D.  
È UN MARCHIO REGISTRATO  
DA HAPPY SOUND SRL  
PER L'ITALIA E RSM IN DATA 31/01/2014.  
L'UTILIZZO DEL MARCHIO È CONSENTITO  
SOLO ALLA NOSTRA CLIENTELA.

**NUOVISSIMA TECNOLOGIA**

**50% DI LUCE EXTRA**

**GAS ALLO XENON INIETTATO ALL'INTERNO**

**OMOLOGATE LUNGA DURATA**



**LUCE BIANCA FREDDA  
UGUALE AI KIT ALLO XENON**

LE LAMPADINE ORIGINALI H.O.D. SONO IL FRUTTO DI UNA NUOVISSIMA TECNOLOGIA ALL'AVANGUARDIA, STUDIATA E BREVETTATA NEGLI STATI UNITI. LE H.O.D. NON SONO IN VETRO COME TUTTI GLI ALTRI TIPI DI LAMPADINE, MA SONO REALIZZATE AL QUARZO, ALL'INTERNO È CONTENUTO REALMENTE IL GAS XENON, LO STESSO GAS PRESENTE NELLE LAMPADINE DEI KIT ALLO XENON.

LA PARTICOLARE FORMA BOMBATA CHE RICORDA UN'OLIVA, PERMETTE LA COMBUSTIONE DEL GAS ALLO XENON CONTENUTO ALL'INTERNO DELLE LAMPADINE, A BASSO VOLTAGGIO,

QUINDI DIRETTAMENTE CON L'IMPIANTO ORIGINALE DEL VEICOLO A 12 VOLT E 24 VOLT, SENZA LA NECESSITÀ DI INSTALLARE LE CENTRALINE BALLAST AD ALTA TENSIONE.

CON LE H.O.D. SI OTTIENE UNA LUCE BIANCA FREDDA E BRILLANTE 5500K, UGUALE AI KIT ALLO XENON, PERTANTO È GARANTITA **UNA ILLUMINAZIONE SUPERIORE DEL 50% CON UNA ESTETICA MOLTO ELEGANTE.**

LE H.O.D. SONO INDISPENSABILI PER OTTENERE UNA ILLUMINAZIONE CHIARA E PROFONDA DELLA STRADA, RIDUCENDO IL RISCHIO DI INCIDENTI, SENZA DARE ALCUN FASTIDIO AGLI ALTRI VEICOLI.

LE NOSTRE H.O.D. HANNO UNA LUNGA DURATA E SONO LEGALI AVENDO TUTTE LE OMOLOGAZIONI RICHIESTE DALLA LEGGE, PERTANTO IN CASO DI POSTO DI BLOCCO DELLE FORZE DELL'ORDINE SI È IN PIENA REGOLA, ANCHE IN CASO DI REVISIONE DEL VEICOLO.

LE H.O.D. HANNO GLI STESSI WATT DI ASSORBIMENTO DELLE LAMPADINE ORIGINALI E SCALDANO IN EGUAL MISURA, PERTANTO È GARANTITO CHE NON RIPORTANO ALCUNA PROBLEMATICA ALL'IMPIANTO DEL VEICOLO, ED IL COMPUTER DI BORDO NON SEGNALE ALCUN ERRORE.

LE H.O.D. POSSONO ESSERE INSTALLATE SUGLI ANABBAGLIANTI, ABBAGLIANTI E FENDINEBBIA DI QUALSIASI VEICOLO.



**DIFFIDATE DELLE NUMEROSE IMITAZIONI IN COMMERCIO NON OMOLOGATE!  
LUMINOSITÀ 2500 LM - VISIBILITÀ OLTRE GLI 80 METRI**

BASE	CODICE	DESCRIZIONE	KELVIN	VOLT	WATT
HB1	HOD.HB1	COPPIA LAMPADINE H.O.D. LUCE BIANCA FREDDA come gli xenon	5500k	12 V	65/45 W
HB4/9006	HOD.HB4	COPPIA LAMPADINE H.O.D. LUCE BIANCA FREDDA come gli xenon	5500k	12 V	55 W
HB3/9005	HOD.HB3	COPPIA LAMPADINE H.O.D. LUCE BIANCA FREDDA come gli xenon	5500k	12 V	55 W
HB5	HOD.HB5	COPPIA LAMPADINE H.O.D. LUCE BIANCA FREDDA come gli xenon	5500k	12 V	65/55 W
H8	HOD.H8	COPPIA LAMPADINE H.O.D. LUCE BIANCA FREDDA come gli xenon	5500k	12 V	55 W
H9	HOD.H9	COPPIA LAMPADINE H.O.D. LUCE BIANCA FREDDA come gli xenon	5500k	12 V	65 W
H7	HOD.H7	COPPIA LAMPADINE H.O.D. LUCE BIANCA FREDDA come gli xenon	5500k	12 V	55 W
H4	HOD.H4	COPPIA LAMPADINE H.O.D. LUCE BIANCA FREDDA come gli xenon	5500k	12 V	55/60 W
H3	HOD.H3	COPPIA LAMPADINE H.O.D. LUCE BIANCA FREDDA come gli xenon	5500k	12 V	55 W
H11	HOD.H11	COPPIA LAMPADINE H.O.D. LUCE BIANCA FREDDA come gli xenon	5500k	12 V	55 W
H10	HOD.H10	COPPIA LAMPADINE H.O.D. LUCE BIANCA FREDDA come gli xenon	5500k	12 V	42 W
H1	HOD.H1	COPPIA LAMPADINE H.O.D. LUCE BIANCA FREDDA come gli xenon	5500k	12 V	55 W
H7	HOD.24VH7	COPPIA LAMPADINE H.O.D. LUCE BIANCA FREDDA come gli xenon	5500k	24 V	70 W
H4	HOD.24VH4	COPPIA LAMPADINE H.O.D. LUCE BIANCA FREDDA come gli xenon	5500k	24 V	75/70 W
H3	HOD.24VH3	COPPIA LAMPADINE H.O.D. LUCE BIANCA FREDDA come gli xenon	5500k	24 V	70 W
H1	HOD.24VH1	COPPIA LAMPADINE H.O.D. LUCE BIANCA FREDDA come gli xenon	5500k	24 V	70 W



## EFFETTO GAS XENON - LUCE BIANCA FREDDA



### LINEA AUTO 12 VOLT

- LP.H10WHITE COPPIA LAMPADINE H10 SUPER WHITE 55 WATT 12 VOLT
- LP.H11WHITE COPPIA LAMPADINE H11 WHITE 55 WATT 12 VOLT
- LP.H13WHITE COPPIA LAMPADINE H13 SUPER WHITE 55 WATT 12 VOLT
- LP.H15WHITE COPPIA LAMPADINE H15 SUPER WHITE 55/15 WATT 12 VOLT
- LP.H16WHITE COPPIA LAMPADINE H16 SUPER WHITE 35 WATT 12 VOLT
- LP.H1WHITE COPPIA LAMPADINE H1 WHITE 55 WATT 12 VOLT
- LP.H3WHITE COPPIA LAMPADINE H3 WHITE 55 WATT 12 VOLT
- LP.H4WHITE COPPIA LAMPADINE H4 WHITE 90/100 WATT 12 VOLT
- LP.H7WHITE COPPIA LAMPADINE H7 WHITE 55 WATT 12 VOLT
- LP.H8WHITE COPPIA LAMPADINE H8 SUPERWHITE 55 WATT 12 VOLT
- LP.H9WHITE COPPIA LAMPADINE H9 WHITE 55 WATT 12 VOLT
- LP.HB1WHITE COPPIA LAMPADINE HB1 12 VOLT SUPER WHITE 55 WATT 12 VOLT
- LP.HB3WHITE COPPIA LAMPADINE HB3 WHITE 55 WATT 12 VOLT
- LP.HB4WHITE COPPIA LAMPADINE HB4 WHITE 55 WATT 12 VOLT
- LP.HB5WHITE COPPIA LAMPADINE HB5 SUPER WHITE 55 WATT 12 VOLT
- LP.T10WHITE COPPIA LAMPADINE ALOGENE T10 SUPER WHITE 5 WATT 12 VOLT
- LP.T20WHITE COPPIA LAMPADINE ALOGENE T20 SUPER WHITE 21/5 WATT 12 VOLT
- LP.HIR2WHITE COPPIA LAMPADINE HIR2 SUPER WHITE 55 WATT 12 VOLT

### LINEA TRUCK 24 VOLT

- LP.24VH1WHITE COPPIA LAMPADINE 24 VOLT H1 70W SUPER WHITE
- LP.24VH3WHITE COPPIA LAMPADINE 24 VOLT H3 70W SUPER WHITE
- LP.24VH4WHITE COPPIA LAMPADINE 24 VOLT H4 75/70W SUPER WHITE
- LP.24VH7WHITE COPPIA LAMPADINE 24 VOLT H7 70W SUPER WHITE
- LP.24VT10WHITE COPPIA LAMPADINE ALOGENE T10 SUPER WHITE 5 WATT 24 VOLT



### LINEA 12 VOLT

- LP.T4W 10PZ LAMPADA 12 VOLT T4W BA9S
- LP.T5W 10 PZ LAMPADA T5 W1,2W 12V 1,2W
- LP.T20Y21W 10 PZ LAMPADA T20 WY21W 12V 21W ARANCIONE
- LP.T20Z1W 10 PZ LAMPADA T20 W21W 12V 21W
- LP.T20Z15W 10 PZ LAMPADA T20 W21/5W 12V 21/5W
- LP.T15W 10 PZ LAMPADA T15 W18W 12V
- LP.T11/41 10 PZ LAMPADA ALOGENA T11 SILURO 41MM 5WATT
- LP.T11/39 10 PZ LAMPADA ALOGENA T11 SILURO 39MM 5WATT
- LP.T11/36 10 PZ LAMPADA ALOGENA T11 SILURO 36MM 5WATT
- LP.T10/5W 10PZ LAMPADA 12 VOLT W5W TUTTO VETRO
- LP.R2640 LAMPADA ASSIMMETRICA R2 G40 45/40W P45T
- LP.HS1 LAMPADA ALOGENA HS1 12 VOLT 35/35W PX43T (MOTO)
- LP.H7 LAMPADA H7 12V 55WATT
- LP.H6 LAMPADA ALOGENA H6 12VOLT 35/35W BA20D (SCOOTER)
- LP.H5 LAMPADA H5 12V 60/55WATT
- LP.H4 LAMPADA ALOGENA H4 60/55W
- LP.H3 LAMPADA H3
- LP.H1 LAMPADA 12 VOLT H1 55W
- LP.BA15D 10 PZ LAMPADA ALOGENA 12 VOLT S25 P21/5W
- LP.BA15S 10 PZ LAMPADA S25 PY21W BAU15S 12V 21W -ARANCIO
- LP.BA9S 10 PZ LAMPADA H6W BA9S 12V 6W (PIEDI STORTI SFALSATI)
- LP.BA15S5W 10PZ LAMPADA ALOGENA G 18,5 12V5W R5W
- LP.BA15S10W 10 PZ LAMPADA ALOGENA G 18,5 12V 10W R10W
- LP.BA15S 10 PZ LAMPADA ALOGENA 12 VOLT S25 P21W
- LP.B35 LAMPADA ALOGENA B35 12 VOLT 35/35 W BA20D (SCOOTER)

### LINEA 24 VOLT

- LP.24VT105 CONFEZIONE 10PZ LAMPADA ALOGENA 24V T10W W5W
- LP.24VT5W CONFEZIONE 10PZ LAMPADA ALOGENA T5 W1,2W 24V 1,2W
- LP.24VT4W CONFEZIONE 10PZ LAMPADA ALOGENA T4W BA9S T8,5 24V 4W
- LP.24VT11/41 CONFEZIONE 10PZ LAMPADA ALOGENA SILURO T11 24V 10W 41mm
- LP.24VH7 LAMPADA ALOGENA 24 VOLT H7 70W
- LP.24VH4 LAMPADA ALOGENA 24 VOLT H4 75/70W
- LP.24VH3 LAMPADA ALOGENA 24 VOLT H3 70W
- LP.24VH1 LAMPADA ALOGENA 24 VOLT H1 70W
- LP.24VBA15D CONFEZIONE 10PZ LAMPADA ALOGENA S25 24V 21/5W
- LP.24VBA15SA CONFEZIONE 10PZ LAMPADA ALOGENA S25 BA15S 24V 21W ARANCIONE
- LP.24VBA15S5W CONFEZIONE 10PZ LAMPADA ALOGENA G18,5 24V 5W
- LP.24VBA15S10W CONFEZIONE 10PZ LAMPADA ALOGENA G18,5 24V 10W
- LP.24VBA15S CONFEZIONE 10PZ LAMPADA ALOGENA S25 24V 21W





COMMERCIAL & MARKETING DIRECTOR - Fabio Gentile  
fabiogentile@happysoundgroup.com - +39 345 3222107

IMPORT/EXPORT DIRECTOR - Fabio Gentile  
fabiogentile@happysoundgroup.com - +39 345 3222107

DIRETTORE AMMINISTRATIVO - Giovanni Terenzi - info@happysound.it

DIRETTORE TECNICO - Giovanni Terenzi - info@happysound.it

TRASMISSIONE ORDINI - ordini.hsgroup@gmail.com

SEGRETERIA - Francesca Maria Ivagnes - happysoundsanmarino@gmail.com

ASSISTENZA TECNICA - service.hsgroup@gmail.com

**VUOI RICEVERE ASSISTENZA TECNICA?**

**SCRIVI AL NUMERO +39 345 3222107**

**OPPURE AL NUMERO +39 331 9980383**

**PER ESSERE INSERITO NEL NOSTRO**

**GRUPPO DI WHATSAPP NAZIONALE,**

**DEDICATO ESCLUSIVAMENTE**

**ALL'ASSISTENZA TECNICA SUL LED AUTOMOTIVE**



[www.happysoundgroup.com](http://www.happysoundgroup.com)

 **HAPPY SOUND GROUP ( H S GROUP)**

 **hs\_group\_official**

 **hsgroup.ledspecialist**

HAPPY SOUND SRL

Strada del Bargello, 80 - 47891 Falciano (RSM) - Tel. 0549 970563 - Fax 0549 972275

[info@happysoundgroup.com](mailto:info@happysoundgroup.com)

